

NIBCO®

AHEAD OF THE FLOW®

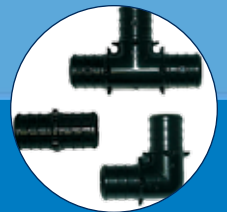
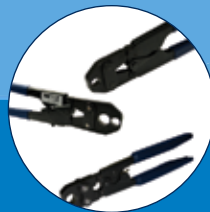
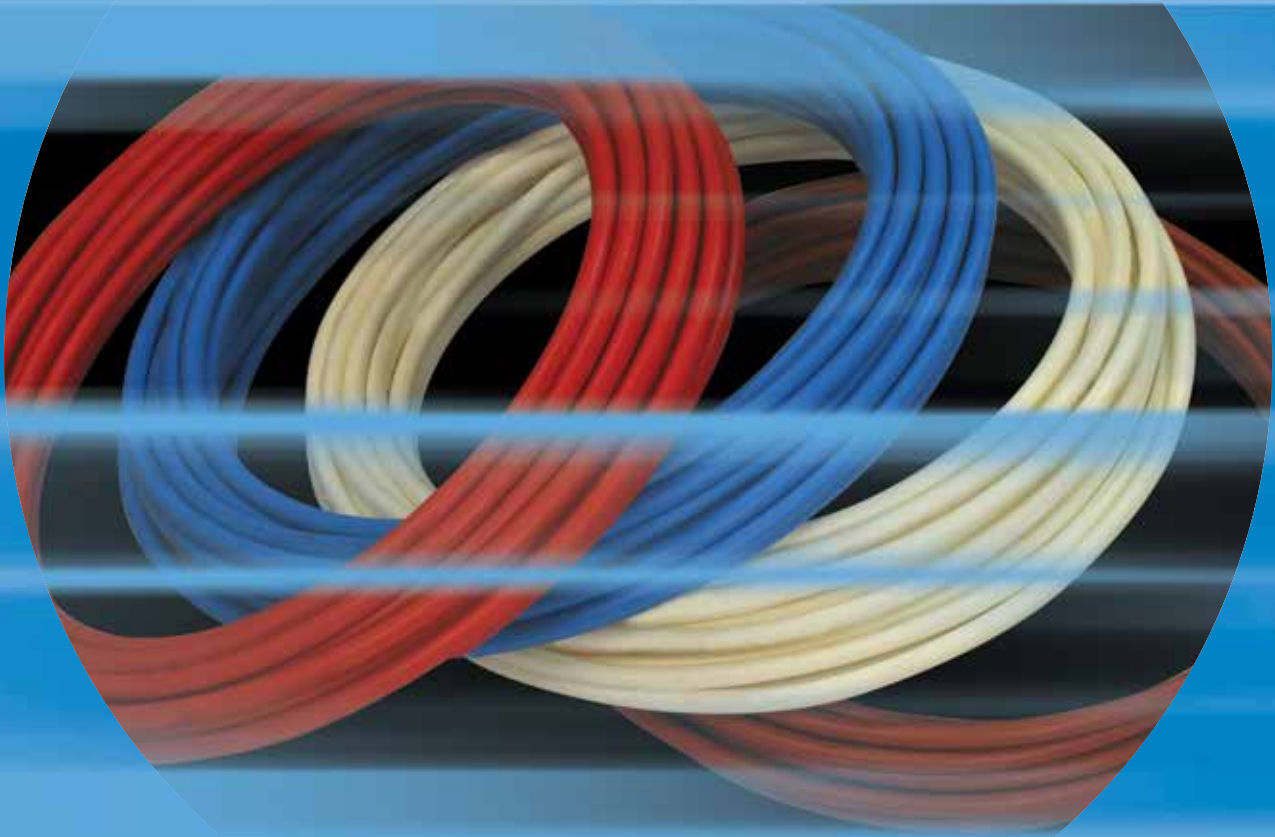

NIBCO® PEX
Piping Systems

Business-to-Business Solutions

Look to NIBCO for technology leadership.

The velocity with which e-business evolves demands that new products and services be continuously developed and introduced to keep our customers at the center of our business efforts. NIBCO provides an entire suite of business-to-business solutions that is changing the way we interact with customers.



[NIBCOpartner.comSM](http://NIBCOpartner.com) is an exclusive set of secure web applications that allow quick access to customer-specific information and online order processing. This self-service approach gives you 24/7 access to your order status putting you in total control of your business.

Real time information includes:

- Online order entry
- Viewable invoices & reports
- Inventory availability
- Current price checks
- Order status
- Online library of price sheets, catalogs & submittals



Electronic Data Interchange (EDI) makes it possible to trade business documents at the speed of light. This technology cuts the cost of each transaction by eliminating the manual labor and paperwork involved in traditional order taking. This amounts to cost-savings, increased accuracy and better use of resources.

With EDI, you can trade:

- Purchase orders
- PO Acknowledgements
- Invoices
- Product activity data
- Advanced ship notices
- Remittance advice



Vendor Managed Inventory (VMI), a sophisticated service for automated inventory management, reduces your overhead by transferring inventory management, order entry and forecasting to NIBCO. This is an on-going, interactive partnership with NIBCO.

Through automation, VMI brings results:

- Improves customer service
- Optimum inventory efficiencies
- Better forecasting
- Cuts transaction costs
- Peace of mind
- Relief from day-to-day management



Visit our website for the most current information.

Table Of Contents

Introduction.....	4
Material Selection.....	6
NIBCO [®] PEX Tube.....	10
NIBCO [®] PEX Metal Insert Fittings.....	16
NIBCO [®] PEX Plastic Insert Fittings.....	21
NIBCO [®] PEX Push 'N Go Fittings.....	23
NIBCO [®] PEX Connections.....	25
NIBCO [®] PEX Manifolds.....	26
NIBCO [®] PEX Valves.....	30
NIBCO [®] PEX Radiant.....	31
NIBCO [®] PEX Tools.....	34
NIBCO [®] PEX Installation Accessories.....	37
Warranty.....	38

NIBCO® PEX is a Complete System

NIBCO® PEX tubing, fittings, valves, and manifolds are designed to be used as a complete system. Therefore, NIBCO cannot guarantee that tubing and/or components from other systems are compatible for use with the NIBCO® PEX system. NIBCO offers more versatility with the choice of three different connections - crimp, clamp or sleeve.

The NIBCO® PEX Manufacturing Process

Cross-linking is the process that gives NIBCO® PEX tubing its superior characteristics. The long, simple chains in a polyethylene molecule are altered to form a more stable, three-dimensional network. This process changes the material from a thermoplastic into a thermoset. A thermoset differs from a thermoplastic because a thermoset cannot be melted and then reformed. This change in molecular structure creates a polyethylene product with enhanced mechanical properties. Many manufacturers use a chemical additive to activate the cross-linking process, but NIBCO employs a sterile, electron beam process that provides superior properties. This process, which is called PEX-c, delivers the highest quality PEX tubing available today, while reducing the use of chemicals.

Standards and Approvals

NIBCO® PEX is an outside diameter controlled tubing of one standard dimension ratio (SDR 9) that is manufactured to comply with the requirements of CSA B137.5, ASTM F 876, and ASTM F 2023. NIBCO® PEX insert fittings and copper crimp rings are manufactured to comply with CSA B137.5 and ASTM F 1807. NIBCO® PEX tubing, fittings, and crimp rings are tested as a system to the requirements of ASTM F 877. NIBCO® PEX tubing components are listed for compliance to NSF/ANSI 14 and NSF/ANSI 61 by NSF International for use in potable water systems. NIBCO® PEX tubing has also been tested and certified by the International Association of Plumbing and Mechanical Officials (IAPMO).



Operating Limits

Water: 160 PSI @ 73° F (1.10 MPa @ 23° C)
100 PSI @ 180° F (0.69 MPa @ 82° C)
80 PSI @ 200° F (0.55 MPa @ 93° C)

Chlorinated Water: 80 PSI @ 140° F (0.55 MPa @ 60° C)

The water temperature must be 140° F (60° C) or lower and the water pressure must be 80 PSI (0.55 MPa) or lower

Thermal Expansion

Heated water expands and must be accommodated within the plumbing system. Protection against increased water pressure from thermal expansion utilizing a pressure relief valve and expansion tank to keep pressure under the maximum of 80 PSI (0.55 MPa) must be incorporated in the system.

Visit our website for the most current information.

Look to NIBCO for Leadership on PEX Tubing Systems

NIBCO is proud to offer PEX for potable water distribution and radiant heating. With over 100 years of experience, you can trust NIBCO to provide the highest quality PEX products.

NIBCO® PEX tubing is processed through an electron beam in order to enhance the mechanical properties over conventional polyethylene. Available in a range from 1/4" to 1-1/4" copper tube size, NIBCO sets a new standard in PEX plumbing products.

NIBCO® PEX Pipe Offers Significant Advantages:

- NIBCO® PEX is pliable and can be easily straightened after removal from the coil.
- NIBCO® PEX has greater dimensional stability. The outside diameter dimensions of our tubes are held to strict tolerances. This means a better fit for you with no sliding of copper crimp rings on the tube.
- NIBCO® PEX is chlorine-resistant.
- NIBCO® PEX is non-toxic and employs no toxic chemicals in the manufacturing process, unlike other PEX manufacturing methods.
- NIBCO® PEX will not leach taste or odor and keeps water clear and clean.
- NIBCO® PEX requires fewer fittings than a traditional rigid plumbing system and is easier to install.
- NIBCO® PEX is abrasion resistant.
- NIBCO® PEX offers three different connection methods - crimp, clamp and sleeve.

Installation Notes

Use of recirculating loops with hot water distribution is gaining popularity in some areas of the country. However, there is debate about the efficiency of these systems due to the constant heating of hot water including during periods of low demand. Data published in the PPI/PPFA/NAHB PEX Design Guide shows a properly designed Home Run manifold system can reduce time to deliver hot water and water use 30 – 40% without recirculation.

If recirculating loops are used with NIBCO PEX, the use of a timer is recommended and the following conditions must be observed:

Max Pressure	80 psi @ 140°F
Max Recirculation Time	12 hrs/day

Please note many building codes forbid constant recirculation and require the use of a timer or other device to make water heating periodic in nature.

Visit our website for the most current information.

Material Selection

Plastic Piping Standards

Many commercial, industrial, and governmental standards or specifications are available to assist the design engineer in specifying plastic piping systems. Standards most frequently specified in plastic piping systems are American Society for Testing and Materials (ASTM) Standards. Below is a list and description of those standards most typically applied to industrial plastic piping.

Polyethylene (PE)

Polyethylene is the most common olefin material and is typically used in transporting water. Because olefins cannot be joined with cements, barbed insert fittings are used for mechanical assembly. PE is light weight, low cost, has excellent chemical resistance, low coefficient of friction, and is non-toxic.

Cross-Linked Polyethylene (PEX)

PEX is the common name for cross-linked polyethylene. PEX tubing is predominantly used in water distribution systems, hydronic radiant heating systems, and natural gas systems.

Almost all PEX is made from high density polyethylene (HDPE). PEX contains cross-linked bonds that are introduced into the polymer structure, changing the thermoplastic into a thermoset. Cross-linking is accomplished during or after the extrusion of the tubing. The required degree of cross-linking, according to ASTM F 876, is between 65 to 89 percent.

The cross-linking process improves high-temperature mechanical properties, low-temperature impact, tensile strength, resistance to brittle fracture, and scratch resistance properties.

Cross-linking may be done by the peroxide (Engel) method, silane (moisture cure) method, or electron beam method. NIBCO® PEX is produced by the electron beam method. This is the cleanest and most environmentally friendly of the three methods. Also this method does not involve other chemicals and uses only high-energy electrons to split the carbon-hydrogen bonds and facilitate cross-linking.

Polyphenylsulfone (PPSU)

Polyphenylsulfone is a thermoplastic that is tough, rigid, high-strength, and retains its properties between -148° F and 302° F (-100° C and 150° C). PPSU has very high dimensional stability; the size change when exposed to boiling water or 302° F (150° C) air generally falls below 0.1 percent. Polyphenylsulfone is highly resistant to mineral acids, alkali, and electrolytes, in pH ranging from 2 to 13. PPSU is resistant to oxidizing agents; therefore, can be cleaned by bleaches. Also, PPSU is resistant to surfactants and hydrocarbon oils. However, PPSU is not resistant to low-polar organic solvents (e.g., ketones and chlorinated hydrocarbons) and aromatic hydrocarbons. In addition, PPSU is often chosen for difficult applications including high water temperatures, chlorides, or when water quality may increase the risk of dezincification, a type of corrosion that can adversely affect metal fittings.

Brass

Brass is the term used for copper alloys where zinc is the principle alloying element along with copper. Brass has a yellow color, somewhat similar to gold. Brass plumbing components may be machined from extruded shapes, forged, or cast. This alloy is mainly used for decorative fixtures, plumbing components, and electrical applications. Today, almost 90% of all brass alloys are recycled.

Copper (Cu)

Copper (Cu) is a natural element that has historically been the dominant material used in plumbing, heating, cooling, and other piping applications. Copper is a ductile metal with excellent thermal conductivity and is corrosion resistant. The materials used in copper piping products comply with the requirements of specifications established by the American Society for Testing and Materials (ASTM). The alloy customarily used for copper tube and copper fittings is designated as C12200 (Copper No. 122). This alloy contains a minimum of 99.9% pure copper and is deoxidized by the addition of phosphorus. Other copper alloys may be used.

Visit our website for the most current information.

Material Selection

Plastic Piping Standards

NSF/ANSI 61

Drinking Water System Components - Health Effects. This is the American National Standard for health effects of drinking water system components. This standard establishes the health effects requirements for the chemical contaminants and impurities that are indirectly imparted to drinking water from products, components and materials used in drinking water systems. This Standard is maintained by a Joint Committee with equal representation from regulators (such as; EPA, Health Canada, and state drinking water officials), users (such as; water purveyors, utilities, and engineers) and manufacturers. NSF/ANSI Standard 61 is approved by the American National Standards Institute, which ensures the standard is developed and maintained using an open consensus process and has representation by all stakeholders.

NSF/ANSI 14

Plastics Piping System Components and Related Materials. NSF/ANSI Standard 14 establishes minimum physical, performance, health effects, quality assurance, marking, and record keeping requirements for plastic piping components and related materials such as: Thermoplastic Materials, Thermoset Materials, Non-plastic Components, Piping and Tubing, Fittings and Valves, Appurtenances, Joining Materials, and Gaskets, Ingredients of Materials and Special Engineered Products and Materials. Standard 14 outlines production facility inspection, quality control, short-term performance testing, long-term performance evaluation, and chemical extraction testing of the products to ensure continued compliance. The NSF Mark for these certified products include such things as the manufacturer name or trademark; the certification agency/laboratory name or trademark; the reference performance standard (such as ASTM F 876 and F 877); product end use (pw or rfh), material type designation such as PEX or PEX/AL/PEX; product size, date of production and manufacturer identification code for tubing. For products with size constraints that do not accommodate complete marking, the manufacturer must include all such details on the product packaging.

ASTM Standard F 876

Standard Specification for Cross-linked Polyethylene (PEX) Tubing. This Standard contains finite dimensional requirements for tubing in addition to burst, sustained pressure, and other relevant performance tests at different water temperatures. Other tubing products that are partially comprised of a PEX material are known as composites. These products usually have a PEX or PE outer layer bound to aluminum or an aluminum alloy, and an inner layer of PEX. The aluminum layer in the core of composite tubing involves additional installation and handling considerations. There are currently two ASTM standards that address performance requirements for such products: ASTM F 1281 and ASTM F 1335.

ASTM Standard F 877

Standard Specification for Cross-linked Polyethylene (PEX) Plastic Hot- and Cold-Water Distribution Systems. This Standard contains performance requirements for PEX tubing and fittings systems. Also, this Standard contains test methods and methods of marking for components used in PEX hot- and cold-water distribution systems intended for 100 psi (0.69 MPa) water service up to and including 180°F (82°C).

ASTM Standard F 1807

Standard Specification for Metal Insert Fittings Utilizing a Copper Crimp Ring for SDR9 Cross-linked Polyethylene (PEX) Tubing. This Standard contains material and dimensional requirements for the insert fittings and crimp rings used with PEX tubing. The performance requirements for these products are defined within ASTM F 877.

ASTM Standard F 2098

Specification for Stainless Steel Clamps for Securing SDR9 Cross-Linked Polyethylene (PEX) Tubing to Metal Insert Fittings. This standard covers stainless steel clamps for use with insert fittings that comply with ASTM F 1807, and cross-linked polyethylene (PEX) tubing that complies with ASTM F 876. These clamps are intended as an alternative to the copper-alloy crimp-rings defined in ASTM F 1807 or ASTM F 2159 and for use in 100 psi (689.5 kPa) hot- and cold-water distribution systems operating at temperatures up to and including 180°F (82°C). This Standard includes requirements for materials, workmanship, dimensions, and marking of the stainless steel clamps. Also, these clamps are covered by international patents held by Oetiker International.

ASTM Standard F 2159

Specification for Plastic Insert Fittings Utilizing a Copper Crimp Ring for SDR9 Cross-linked Polyethylene (PEX) Tubing. This Standard covers Polyphenylsulfone insert fittings and copper crimp rings for use with cross-linked polyethylene (PEX) tubing. These fittings are intended for use in 100 psi (689.5 kPa) hot- and cold-water distribution systems operating at temperatures up to and including 180°F (82°C). This Standard includes requirements for material, molded part properties, performance, workmanship, dimensions, and markings for the fittings and rings.

Visit our website for the most current information.

Material Selection

Plastic Piping Standards

ASSE Standard 1061

Removable and Non-Removable Push-Fit Fittings. This Standard covers removable and non-removable push-fit fittings that employ a quick assembly push-fit connector, as well as push-fit connectors integrated into plumbing devices. This Standard applies to fittings that may be approved for use with PEX tubing that conforms to ASTM F 876, Type K, L, and M seamless copper tubing that conforms to ASTM B 88, and CPVC tubing that conforms to ASTM D 2846. The standard includes minimum requirements for materials, performance for the fitting joints, marking, and identification requirements. When this type of fitting connection is used with PEX tubing, a tube liner must be inserted into the end of the tubing before assembly.

NSF-pw

Identification mark for products that meet all applicable performance standards for pressure-rated potable water applications as required by NSF/ANSI Standard 14 and that comply with NSF/ANSI Standard 61 for health effects.

NSF-rfh

Identification mark for products that meet all applicable performance standards for a pressure-rated in-floor heating application as required by NSF/ANSI Standard 14. No health effects evaluation is required.

NSF-61

Identification mark for products that meet the applicable requirements of NSF/ANSI 61.

California Proposition 65

In November 1986, California voters approved a ballot initiative to address concerns about exposures to toxic chemicals. That initiative became The Safe Drinking Water and Toxic Enforcement Act of 1986, better known by its original name, Proposition 65. This Proposition requires the Governor of California to publish a list of chemicals that are known to the State of California to cause cancer, birth defects or other reproductive harm. Over 750 chemicals and materials, including many metals and plastics, have been listed as of December 12, 2006. Second, Manufacturers are required to provide a "clear and reasonable" warning before exposing anyone to a listed chemical. This warning can be given by a variety of means, such as by labeling a consumer product, by posting signs at the workplace, or by publishing notices in a newspaper. A Proposition 65 warning means that the Manufacturer issuing the warning believes that one or more listed chemicals is present in its product, even if it is only present in trace quantities.

Kentucky

Metal insert fittings utilizing a copper crimp ring for cross-linked polyethylene (PEX) tubing must be produced and labeled as ASTM F 1807. Stainless steel clamps substituted for the copper crimp ring must be produced and labeled as ASTM F 2098. Methods of joining other than mentioned above shall be prohibited unless documentation is provided, from the systems manufacturer, honoring full warranty of the system installed. Fittings which have a smaller ID (inside diameter) other than what is required for the insert portion of the fitting shall not be permitted. A system consisting of material from multiple manufacturers (i.e. fittings, tubing and crimp rings) shall be prohibited unless documentation from manufacturers is produced providing full warranty. Connections for PEX systems other than those in section 1 of this regulation will be prohibited.

Visit our website for the most current information.

Fitting Terms and Abbreviations

FIP = Female Iron Pipe
 MIP = Male Iron Pipe
 NPSM = Straight Pipe Thread
 CTS = Copper Tube Size

SVL = Swivel
 PB = Polybutylene

Tube Markings

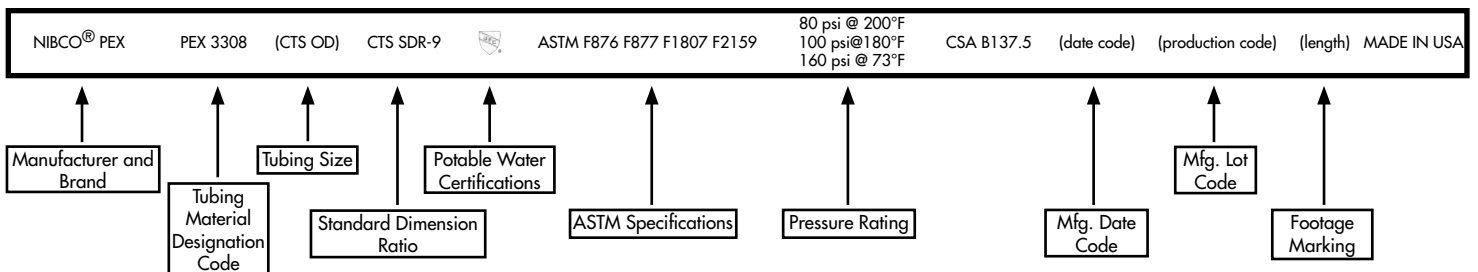

Visit our website for the most current information.

NIBCO® PEX Tube

Potable Water

RED

NP60



PEX Red Sticks

FIGURE NO.	MATERIAL NO.	SIZE	WEIGHT/ FOOT	WEIGHT/ STICK	FEET/ BUNDLE	PIECES/ BUNDLE
NP60	PX60012R*	1/2" x 5'	0.0540	0.27	250	50
NP60	PX60013R*	1/2" x 10'	0.0540	0.54	500	50
NP60	PX60014	1/2" x 20'	0.0540	1.08	1,000	50
NP60	PX60019R*	3/4" x 5'	0.1025	0.51	250	50
NP60	PX60020R*	3/4" x 10'	0.1025	1.03	250	25
NP60	PX60021	3/4" x 20'	0.1025	2.05	500	25
NP60	PX60026R*	1" x 10'	0.1670	1.67	150	15
NP60	PX60027	1" x 20'	0.1670	3.34	300	15

All sticks sold in 5 bundle minimum quantity. Sizes and colors can be mixed to make up the 5 bundle minimum.

NP60



PEX Red Coil

FIGURE NO.	MATERIAL NO.	SIZE	WEIGHT/ FOOT	WEIGHT/ COIL	FEET/ PALLET	COILS/ PALLET
NP60	PX40014	1/2" x 100'	0.0540	5.40	2,000	20
NP60	PX40018	1/2" x 250'	0.0540	13.50	2,500	10
NP60	PX40019*	1/2" x 300'	0.0540	16.20	3,000	10
NP60	PX40020	1/2" x 500'	0.0540	27.00	4,000	8
NP60	PX40022	1/2" x 1000'	0.0540	54.00	5,000	5
NP60	PX40030	3/4" x 100'	0.1025	10.25	1,300	13
NP60	PX40035*	3/4" x 300'	0.1025	30.75	2,100	7
NP60	PX40038	3/4" x 500'	0.1025	51.25	5,000	5
NP60	PX40042*	1" x 100'	0.1670	16.70	800	8
NP60	PX40048*	1" x 300'	0.1670	50.10	900	3
NP60	PX40051*	1" x 500'	0.1670	83.50	1,500	3

*SKU's are assemble-to-order or made-to-order, and may require longer lead times. Contact customer service or your account representative for details.

Visit our website for the most current information.

NIBCO® PEX Tube

Potable Water

WHITE

NP80

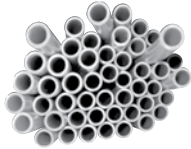

PEX White Sticks

FIGURE NO.	MATERIAL NO.	SIZE	WEIGHT/ FOOT	WEIGHT/ STICK	FEET/ BUNDLE	PIECES/ BUNDLE
NP80	PX60201*	1/4" x 5'	0.0300	0.15	250	50
NP80	PX60202*	1/4" x 10'	0.0300	0.30	500	50
NP80	PX60203*	1/4" x 20'	0.0300	0.60	1,000	50
NP80	PX60206*	3/8" x 5'	0.0410	0.21	250	50
NP80	PX60207*	3/8" x 10'	0.0410	0.41	500	50
NP80	PX60208*	3/8" x 20'	0.0410	0.82	1,000	50
NP80	PX60212	1/2" x 5'	0.0540	0.27	250	50
NP80	PX60213*	1/2" x 10'	0.0540	0.54	500	50
NP80	PX60214	1/2" x 20'	0.0540	1.08	1,000	50
NP80	PX60219*	3/4" x 5'	0.1025	0.51	125	25
NP80	PX60220*	3/4" x 10'	0.1025	1.03	250	25
NP80	PX60221	3/4" x 20'	0.1025	2.05	500	25
NP80	PX60226R*	1" x 10'	0.1670	1.67	150	15
NP80	PX60227	1" x 20'	0.1670	3.34	300	15
NP80	PX60231	1-1/4" x 20'	0.2530	5.06	200	10

All sticks sold in 5 bundle minimum quantity. Sizes and colors can be mixed to make up the 5 bundle minimum.

NP80



PEX White Coil

FIGURE NO.	MATERIAL NO.	SIZE	WEIGHT/ FOOT	WEIGHT/ COIL	FEET/ PALLET	COILS/ PALLET
NP80	PX60204*	1/4" x 25'	0.0300	0.75	2,500	100
NP80	PX40201	1/4" x 100'	0.0300	3.00	4,000	40
NP80	PX40203*	1/4" x 500'	0.0300	15.00	7,500	15
NP80	PX40204*	1/4" x 1000'	0.0300	30.00	5,000	5
NP80	PX60210*	3/8" x 50'	0.0410	2.05	2,500	50
NP80	PX40205	3/8" x 100'	0.0410	4.10	3,500	35
NP80	PX40210*	3/8" x 500'	0.0410	20.50	5,000	10
NP80	PX40212*	3/8" x 1000'	0.0410	41.00	6,000	6
NP80	PX60217*	1/2" x 50'	0.0540	2.70	1,500	30
NP80	PX40214	1/2" x 100'	0.0540	5.40	2,000	20
NP80	PX40219*	1/2" x 300'	0.0540	16.20	3,000	10
NP80	PX40220	1/2" x 500'	0.0540	27.00	4,000	8
NP80	PX40222	1/2" x 1000'	0.0540	54.00	5,000	5
NP80	PX40230	3/4" x 100'	0.1025	10.25	1,300	13
NP80	PX40235*	3/4" x 300'	0.1025	30.75	2,100	7
NP80	PX40238	3/4" x 500'	0.1025	51.25	5,000	5
NP80	PX40242	1" x 100'	0.1670	16.70	800	8
NP80	PX40245*	1" x 200'	0.1670	33.40	1,000	5
NP80	PX40246*	1" x 250'	0.1670	41.75	1,000	4
NP80	PX40248	1" x 300'	0.1670	50.10	1,500	5
NP80	PX40251*	1" x 500'	0.1670	83.50	1,000	2
NP80	PX40254	1-1/4" x 100'	0.2530	25.30	800	8
NP80	PX40255	1-1/4" x 250'	0.2530	63.25	1,000	4

*SKU's are assemble-to-order or made-to-order, and may require longer lead times. Contact customer service or your account representative for details.

Visit our website for the most current information.

NIBCO® PEX Tube

Potable Water

BLUE

NP70



PEX Blue Sticks

FIGURE NO.	MATERIAL NO.	SIZE	WEIGHT/ FOOT	WEIGHT/ STICK	FEET/ BUNDLE	PIECES/ BUNDLE
NP70	PX60112R*	1/2" x 5'	0.0540	0.27	250	50
NP70	PX60113R*	1/2" x 10'	0.0540	0.54	500	50
NP70	PX60114	1/2" x 20'	0.0540	1.08	1,000	50
NP70	PX60119R*	3/4" x 5'	0.1025	0.51	125	25
NP70	PX60120R*	3/4" x 10'	0.1025	1.03	250	25
NP70	PX60121	3/4" x 20'	0.1025	2.05	500	25
NP70	PX60125R*	1" x 5'	0.1670	0.84	75	15
NP70	PX60117R*	1" x 10'	0.1670	1.67	150	15
NP70	PX60127	1" x 20'	0.1670	3.34	300	15

All sticks sold in 5 bundle minimum quantity. Sizes and colors can be mixed to make up the 5 bundle minimum.

NP70



PEX Blue Coil

FIGURE NO.	MATERIAL NO.	SIZE	WEIGHT/ FOOT	WEIGHT/ COIL	FEET/ PALLET	COILS/ PALLET
NP70	PX60115*	1/2" x 25'	0.0540	1.35	1,250	50
NP70	PX40114	1/2" x 100'	0.0540	5.40	2,000	20
NP70	PX40118	1/2" x 250'	0.0540	13.50	2,500	10
NP70	PX40119*	1/2" x 300'	0.0540	16.20	3,000	10
NP70	PX40120	1/2" x 500'	0.0540	27.00	4,000	8
NP70	PX40122	1/2" x 1000'	0.0540	54.00	5,000	5
NP70	PX60122*	3/4" x 25'	0.1025	2.56	1,000	40
NP70	PX60124*	3/4" x 50'	0.1025	5.13	1,250	25
NP70	PX40130	3/4" x 100'	0.1025	10.25	1,300	13
NP70	PX40135*	3/4" x 300'	0.1025	30.75	2,100	7
NP70	PX40138	3/4" x 500'	0.1025	51.25	5,000	5
NP70	PX40142	1" x 100'	0.1670	16.70	800	8
NP70	PX40148	1" x 300'	0.1670	50.10	900	3
NP70	PX40151*	1" x 500'	0.1670	83.50	1,000	2

*SKU's are assemble-to-order or made-to-order, and may require longer lead times. Contact customer service or your account representative for details.

Visit our website for the most current information.

NIBCO® PEX Tube

Potable Water

TERRA COTTA

NP65



PEX Terra Cotta Sticks

FIGURE NO.	MATERIAL NO.	SIZE	WEIGHT/ FOOT	WEIGHT/ STICK	FEET/ BUNDLE	PIECES/ BUNDLE
NP65	PX60506	3/8" x 5'	0.0410	0.21	250	50
NP65	PX60512R	1/2" x 5'	0.0540	0.27	250	50
NP65	PX60513R	1/2" x 10'	0.0540	0.54	500	50
NP65	PX60514	1/2" x 20'	0.0540	1.08	1,000	50
NP65	PX60519R	3/4" x 5'	0.1025	0.51	125	25
NP65	PX60520R	3/4" x 10'	0.1025	1.03	250	25
NP65	PX60521	3/4" x 20'	0.1025	2.05	500	25
NP65	PX60525*	1" x 5'	0.1670	0.84	75	15
NP65	PX60526	1" x 10'	0.1670	1.67	150	15
NP65	PX60527	1" x 20'	0.1670	3.34	300	15

All sticks sold in 5 bundle minimum quantity. Sizes and colors can be mixed to make up the 5 bundle minimum.

NP65



PEX Terra Cotta Coil

FIGURE NO.	MATERIAL NO.	SIZE	WEIGHT/ FOOT	WEIGHT/ COIL	FEET/ PALLET	COILS/ PALLET
NP65	PX60509	3/8" x 25'	0.0410	1.03	1,750	70
NP65	PX40508*	3/8" x 300'	0.0410	12.30	3,000	10
NP65	PX40510*	3/8" x 500'	0.0410	20.50	5,000	10
NP65	PX60515	1/2" x 25'	0.0540	1.35	1,250	50
NP65	PX40514	1/2" x 100'	0.0540	5.40	2,000	20
NP65	PX40518	1/2" x 250'	0.0540	13.50	2,500	10
NP65	PX40519*	1/2" x 300'	0.0540	16.20	3,000	10
NP65	PX40520	1/2" x 500'	0.0540	27.00	4,000	8
NP65	PX60522	3/4" x 25'	0.1025	2.56	1,000	40
NP65	PX40530	3/4" x 100'	0.1025	10.25	1,300	13
NP65	PX40531*	3/4" x 150'	0.1025	15.36	1,500	10
NP65	PX40532*	3/4" x 200'	0.1025	20.50	2,000	10
NP65	PX40534	3/4" x 250'	0.1025	25.63	2,250	9
NP65	PX60528*	1" x 25'	0.1670	4.18	625	25
NP65	PX60530*	1" x 50'	0.1670	8.35	750	15
NP65	PX40542*	1" x 100'	0.1670	16.70	800	8
NP65	PX40544	1" x 150'	0.1670	25.05	900	6
NP65	PX40548	1" x 300'	0.1670	50.10	900	3

*SKU's are assemble-to-order or made-to-order, and may require longer lead times. Contact customer service or your account representative for details.

Visit our website for the most current information.

NIBCO® PEX Tube

Spools and Radiant Heat

SPOOLS

NP60
NP70



PEX Spools

FIGURE NO.	MATERIAL NO.	DESCRIPTION	WEIGHT/ FOOT
NP60	PX40019SP	1/2" X 300' Red Tube On Spool	0.0540
NP70	PX40119SP	1/2" X 300' Blue Tube On Spool	0.0540

RADIANT HEAT

NP75



BARRIER-PEX Coil

FIGURE NO.	MATERIAL NO.	SIZE	WEIGHT/ FOOT	WEIGHT/ COIL	FEET/ PALLET	COILS/ PALLET
NP75	PX50014	1/2" x 100'	0.0535	5.40	2,000	20
NP75	PX50018	1/2" x 250'	0.0535	13.50	2,500	10
NP75	PX50019	1/2" x 300'	0.0535	16.20	3,000	10
NP75	PX50020	1/2" x 500'	0.0535	27.00	4,000	8
NP75	PX50021	1/2" x 600'	0.0535	32.40	4,200	7
NP75	PX50022	1/2" x 1000'	0.0535	54.00	3,000	3
NP75	PX50023	1/2" x 1200'	0.0535	64.80	2,400	2
NP75	PX50029	5/8" x 100'	0.0760	7.60	2,000	20
NP75	PX50024	5/8" x 250'	0.0760	19.00	2,500	10
NP75	PX50026	5/8" x 500'	0.0760	38.00	3,500	7
NP75	PX50028	5/8" x 1000'	0.0760	76.00	3,000	3
NP75	PX50030	3/4" x 100'	0.1030	10.30	1,300	13
NP75	PX50034	3/4" x 250'	0.1030	25.75	2,250	9
NP75	PX50035	3/4" x 300'	0.1030	30.90	2,100	7
NP75	PX50038	3/4" x 500'	0.1030	51.50	2,500	5
NP75	PX50039	3/4" x 600'	0.1030	61.80	1,800	3
NP75	PX50040	3/4" x 1000'	0.1030	103.00	2,000	2
NP75	PX50041	3/4" x 1,200'	0.1030	123.60	2,400	2
NP75	PX50042	1" x 100'	0.1670	16.70	800	8
NP75	PX50048	1" x 300'	0.1670	50.10	900	3
NP75	PX50051	1" x 500'	0.1670	83.50	1,000	2

NP75



BARRIER-PEX Sticks

FIGURE NO.	MATERIAL NO.	SIZE	WEIGHT/ FOOT	WEIGHT/ STICK	FEET/ BUNDLE	PIECES/ BUNDLE
NP75	PX50066*	1/2" x 5'	0.0535	0.285	500	100
NP75	PX50068	1/2" x 20'	0.0535	1.140	500	25
NP75	PX50061*	3/4" x 5'	0.1023	0.525	200	40
NP75	PX50069	3/4" x 20'	0.1023	2.100	200	10
NP75	PX50073*	1" x 5'	0.1670	0.835	100	20
NP75	PX50064	1" x 20'	0.1670	3.340	100	5

BARRIER-PEX is used for radiant systems with ferrous components (e.g. cast iron boiler).

The oxygen barrier layer meets the standard DIN 4276.

*SKU's are assemble-to-order or made-to-order, and may require longer lead times. Contact customer service or your account representative for details.

Visit our website for the most current information.

NIBCO® PEX Tube

Icemaker Tubing and Risers

NP80



PEX Icemaker Tubing

FIGURE NO.	MATERIAL NO.	SIZE	WEIGHT/ FOOT	WEIGHT/ COIL	FEET/ PALLET	COILS/ PALLET
NP80	PX40700	1/8" (1/4" OD) x 100'	0.0300	0.88	2,500	25

RISERS

- NP45
- NP45F
- NP46
- NP46F
- NP47

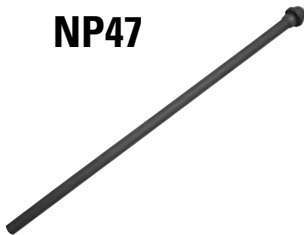

PEX Riser Tubing

FIGURE NO.	MATERIAL NO.	DESCRIPTION	WEIGHT/ PIECE	BAG QTY.	MASTER CTN. QTY.
NP45F	PX01212	3/8" x 20" PEX Lav Tube w/Ferrule	0.0460	50	50
NP45	PX01222	3/8" x 30" PEX Lav Tube	0.0690	50	50
NP45F	PX01232	3/8" x 36" PEX Lav Tube w/Ferrule	0.0840	50	50
NP46F	PX01242	3/8" x 12" PEX Closet Tube w/Ferrule	0.0290	50	50
NP46F	PX01252	3/8" x 20" PEX Closet Tube w/Ferrule	0.0510	50	50
NP47	PX01260	3/8" Nominal Poly Ferrule	0.0010	50	3,000

INSULATED TUBING

NP90



Insulated PEX Tubing

FIGURE NO.	MATERIAL NO.	DESCRIPTION	WEIGHT/ FOOT (EA.)	WEIGHT/ COIL	FEET/ PALLET	COILS/ PALLET
NP90	PX41010	2 x 1" x 75' Insulated PEX	0.8000	60	75	1
NP90	PX41015	2 x 1" x 100' Insulated PEX	0.8000	80	100	1
NP90	PX41020	2 x 1" x 125' Insulated PEX	0.8000	100	125	1
NP90	PX41025	2 x 1" x 150' Insulated PEX	0.8000	120	150	1

NP90CAP



Insulated PEX Tubing Accessories

FIGURE NO.	MATERIAL NO.	DESCRIPTION	WEIGHT/ PIECE	BAG QTY.	MASTER CTN. QTY.
NP90CAP	PX41005	Insulated PEX End Cap 2 x 1"	0.4000	1	25

Visit our website for the most current information.

NIBCO® PEX
Metal Insert Fittings

COUPLINGS

NP01-LF
NP01R-LF



PEX Lead-Free* Performance Bronze™ Insert Couplings

FIGURE NO.	MATERIAL NO.	SIZE	WEIGHT	BAG QTY.	MASTER CTN. QTY.
NP01-LF	PX80521A	1/2"	0.032	50	1,000
NP01R-LF	PX80540A	3/4 x 1/2"	0.056	25	500
NP01-LF	PX80550A	3/4"	0.058	25	500
NP01R-LF	PX80560E	1 x 3/4"	0.093	15	120
NP01-LF	PX80570A	1"	0.106	15	120
NP01R-LF	PX80590E	1 1/4 x 3/4"	0.095	10	80
NP01R-LF	PX80600X	1 1/4 x 1"	0.126	10	80
NP01-LF	PX80580E	1 1/4"	0.126	25	150

ELBOWS

NP07-LF
NP07R-LF



PEX Lead-Free* Performance Bronze™ Insert Elbows

FIGURE NO.	MATERIAL NO.	SIZE	WEIGHT	BAG QTY.	MASTER CTN. QTY.
NP07-LF	PX80631A	1/2"	0.0440	50	750
NP07R-LF	PX80640E	3/4 x 1/2"	0.1280	25	300
NP07-LF	PX80650E	3/4"	0.0820	25	300
NP07-LF	PX80660X	1"	0.1800	15	150
NP07-LF	PX80670E	1 1/4"	0.2730	10	100

TEES

NP11-LF
NP11R-LF

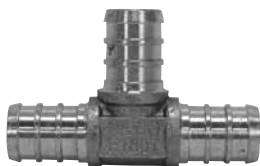

PEX Lead-Free* Performance Bronze™ Insert Tees

FIGURE NO.	MATERIAL NO.	SIZE	WEIGHT	BAG QTY.	MASTER CTN. QTY.
NP11-LF	PX80710X	1/2"	0.065	50	500
NP11R-LF	PX80720E	1/2 x 1/2" x 3/4"	0.150	25	250
NP11R-LF	PX80730E	3/4 x 1/2" x 1/2"	0.128	25	250
NP11R-LF	PX80740E	3/4 x 1/2" x 3/4"	0.102	25	250
NP11R-LF	PX80750A	3/4 x 3/4" x 1/2"	0.092	25	250
NP11-LF	PX80760E	3/4"	0.125	25	250
NP11R-LF	PX80800E	1 x 1 x 1/2"	0.130	15	120
NP11R-LF	PX80810E	1 x 1" x 3/4"	0.211	15	120
NP11-LF	PX80820X	1"	0.198	10	120
NP11-LF	PX80860X	1 1/4"	0.355	10	60
NP11R-LF	PX80880X	1 1/4" x 1" x 1"	0.289	10	60
NP11R-LF	PX80870E	1 1/4" x 1 1/4" x 1"	0.275	10	80

*Weighted average lead content ≤ 0.25%

Visit our website for the most current information.

NIBCO® PEX

Metal Insert Fittings

STUB OUTS*

NP21
NP21S



PEX Copper Stub Out Elbows

FIGURE NO.	MATERIAL NO.	DESCRIPTION	WEIGHT	BAG QTY.	MASTER CTN. QTY.
NP21	PX80950	1/2" Stub Out Elbow (3-1/2" x 8")	0.2580	25	25
NP21	PX80960	3/4" PEX Stub Out Elbow (4" x 8")	0.4120	50	50
NP21S	PX80970	1/2" Stub Out Elbow w/Flange (3-1/2"-8")	0.3070	25	25
NP21S	PX80990	3/4" Stub Out Elbow w/Sq O Strap (4"-8")	0.4860	25	25

NP43



PEX Copper Straight Stub Outs

FIGURE NO.	MATERIAL NO.	DESCRIPTION	WEIGHT	BAG QTY.	MASTER CTN. QTY.
NP43	PX80980	1/2" x 8" PEX Straight Stub Out	0.1780	25	1200

* Not recommended for use with Stainless Steel Clamps

NP24A



PEX Copper Tub/Shower Pressure Connections

FIGURE NO.	MATERIAL NO.	DESCRIPTION	WEIGHT	BOX QTY.	MASTER CTN. QTY.
NP24A	PX81170	1/2" PEX x 1/2" M Sweat (6x3) Tub/Shw	0.2000	25	25

Visit our website for the most current information.

NIBCO® PEX
Metal Insert Fittings

ADAPTERS

NP22F-LF



PEX Lead-Free* Performance Bronze™
PEX x Sweat Elbow Adapters

FIGURE NO.	MATERIAL NO.	DESCRIPTION	WEIGHT	BAG QTY.	MASTER CTN. QTY.
NP22F	PX81030E	3/4" PEX x 3/4" Female Sweat Elbow Adapter	0.1080	10	50

NP23-LF



PEX Lead-Free* Performance Bronze™
PEX x Male Sweat Adapters

FIGURE NO.	MATERIAL NO.	DESCRIPTION	WEIGHT	BAG QTY.	MASTER CTN. QTY.
NP23-LF	PX81070E	1/2 PEX x 1/2" Male Sweat Adapter	0.032	50	500
NP23-LF	PX81130A	3/4 PEX x 3/4" Male Sweat Adapter	0.064	25	250
NP23-LF	PX81100A	1 PEX x 1" Male Sweat Adapter	0.116	15	120

NP23F-LF



PEX Lead-Free* Performance Bronze™
PEX x Female Sweat Adapters

FIGURE NO.	MATERIAL NO.	DESCRIPTION	WEIGHT	BAG QTY.	MASTER CTN. QTY.
NP23F-LF	PX81120E	1/2 PEX x 1/2" Female Sweat Adapter	0.032	50	500
NP23F-LF	PX01676E	1/2 PEX X 3/4" Female Sweat Adapter	0.084	50	500
NP23F-LF	PX81130E	3/4 PEX x 3/4" Female Sweat Adapter	0.062	25	250
NP23F-LF	PX81140E	1 PEX x 1" Female Sweat Adapter	0.130	15	120

NP25B-LF



PEX Lead-Free* Performance Bronze™ PEX x MIP Adapters

FIGURE NO.	MATERIAL NO.	DESCRIPTION	WEIGHT	BOX QTY.	MASTER CTN. QTY.
NP25B-LF	PX81190X	1/2 PEX x 1/2" MIP Brass Adapter	0.084	50	500
NP25B-LF	PX81200E	1/2 PEX x 3/4" MIP Brass Adapter	0.130	25	250
NP25B-LF	PX81210E	3/4 PEX x 1/2" MIP Brass Adapter	0.087	25	250
NP25B-LF	PX81220E	3/4 PEX x 3/4" MIP Brass Adapter	0.151	10	300
NP25B-LF	PX81250E	3/4 PEX x 1" MIP Brass Adapter	0.209	25	200
NP25B-LF	PX81240E	1 PEX x 3/4" MIP Brass Adapter	0.1370	15	120
NP25B-LF	PX81260E	1 PEX x 1" MIP Brass Adapter	0.242	15	120

*Weighted average lead content ≤ 0.25%

Visit our website for the most current information.

NIBCO® PEX Metal Insert Fittings

ADAPTERS

NP25BE-LF



PEX Lead-Free* Performance Bronze™ PEX x MIP Elbows

FIGURE NO.	MATERIAL NO.	DESCRIPTION	WEIGHT	BOX QTY.	MASTER CTN. QTY.
NP25BE-LF	PX81500X	1/2" PEX x 1/2" MIP Elbow	0.1840	50	250
NP25BE-LF	PX81502E	3/4" PEX x 1/2" MIP Elbow	0.1900	25	250

NP26BS-LF



PEX Lead-Free* Performance Bronze™ Swivel Adapters

FIGURE NO.	MATERIAL NO.	DESCRIPTION	WEIGHT	BOX QTY.	MASTER CTN. QTY.
NP26BS-LF	PX81340A	1/2 PEX x 3/4" NPSM Swivel Adapter - Brass Nut	0.170	25	50
NP26BS-LF	PX81360E	3/4 PEX x 3/4" NPSM Swivel Adapter - Brass Nut	0.150	25	250

NP26PS-LF

NP44-LF



PEX Lead-Free* Performance Bronze™ Faucet and Swivel Adapters

FIGURE NO.	MATERIAL NO.	DESCRIPTION	WEIGHT	BOX QTY.	MASTER CTN. QTY.
NP26PS-LF	PX81330A	3/8 PEX x Faucet Swivel Adapter - Plastic Nut	0.044	25	50
NP26PS-LF	PX02345A	1/2 PEX x Faucet Swivel Adapter - Plastic Nut	0.048	50	500
NP44-LF	PX81380A	1/2 PEX x Closet Swivel Adapter - Plastic Nut	0.062	10	50

NP27P-LF



PEX Lead-Free* Performance Bronze™ Faucet Elbows

FIGURE NO.	MATERIAL NO.	DESCRIPTION	WEIGHT	BAG QTY.	MASTER CTN. QTY.
NP27P-LF	PX02245A	1/2 x 1/2" NPSM Faucet Elbow (Plastic Nut)	0.091	50	250

NOTE: Faucet and Swivel Adapters are to be hand tightened ONLY.

NP26B-LF



PEX Lead-Free* Performance Bronze™ FIP Non-Swivel Adapters

FIGURE NO.	MATERIAL NO.	DESCRIPTION	WEIGHT	BOX QTY.	MASTER CTN. QTY.
NP26B-LF	PX81270X	1/2" x 1/2" FIP Non-Swivel Adapter	0.1200	50	250
NP26B-LF	PX81280X	1/2" x 3/4" FIP Non-Swivel Adapter	0.1320	25	250
NP26B-LF	PX81300X	3/4" x 3/4" FIP Non-Swivel Adapter	0.1650	25	250
NP28B-LF	PX81305X	3/4" x 1" FIP Non-Swivel Adapter	0.1500	15	120
NP26B-LF	PX81310E	1" x 1" FIP Non-Swivel Adapter	0.2280	15	120
NP26B-LF	PX81313E	1 1/4" x 1" FIP Non-Swivel Adapter	0.2290	10	60

*Weighted average lead content ≤ 0.25%

Visit our website for the most current information.

NIBCO® PEX
Metal Insert Fittings

MISCELLANEOUS FITTINGS

NP18-LF



PEX Lead-Free* Performance Bronze™ Insert Plugs

FIGURE NO.	MATERIAL NO.	SIZE	WEIGHT	BAG QTY.	MASTER CTN. QTY.
NP18-LF	PX81450E	1/2"	0.023	50	1,500
NP18-LF	PX81460A	3/4"	0.046	25	1,000
NP18-LF	PX81480E	1"	0.066	15	120
NP18-LF	PX81470E	1 1/4"	0.071	15	120

NP28-LF



PEX Lead-Free* Performance Bronze™ FIP Drop Ear Elbows

FIGURE NO.	MATERIAL NO.	DESCRIPTION	WEIGHT	BOX QTY.	MASTER CTN. QTY.
NP28-LF	PX81400E	1/2" PEX x 1/2" FIP Drop Ear Elbow	0.1780	25	200
NP28-LF	PX81420E	3/4" PEX x 3/4" FIP Drop Ear Elbow	0.2870	25	100

NP29R-LF



PEX Lead-Free* Performance Bronze™ Transition Fittings

FIGURE NO.	MATERIAL NO.	DESCRIPTION	WEIGHT	BAG QTY.	MASTER CTN. QTY.
NP29R-LF	PX02283E	1/2" PEX x 1/2" PB Transition Fitting w/Rings	0.0500	25	250
NP29R-LF	PX02293E	3/4" PEX x 3/4" PB Transition Fitting w/ Rings	0.1000	25	100

NP100
NP100SW
NP101



PEX Compression Fittings (not for use with potable water)

FIGURE NO.	MATERIAL NO.	DESCRIPTION	WEIGHT	BAG QTY.	MASTER CTN. QTY.
NP100SW	PX81650	1/2" PEX COMP x COMP Coupling	0.0300	10	80
NP01WT083	PX81610	5/8" PEX COMP x COMP Coupling	0.1800	10	80
NP25W7083	PX81600	5/8" COMP x 3/4" Male Sweat	0.1830	10	80
NP100SWM	PX81640	1/2" COMP x 3/4" Male Sweat	0.0300	10	80

*Weighted average lead content ≤ 0.25%

Visit our website for the most current information.

NIBCO® PEX

Plastic Insert Fittings

NPD01 NPD01R



PEX Poly Couplings

FIGURE NO.	MATERIAL NO.	SIZE	WEIGHT	BAG QTY.	MASTER CTN. QTY.
NPD01	PX00508C	3/8"	0.0070	50	2,500
NPD01R	PX00518C	1/2" x 3/8"	0.0070	50	2,000
NPD01	PX00528C	1/2"	0.0020	50	500
NPD01R	PX00538C	3/4" x 1/2"	0.0100	50	500
NPD01	PX00548C	3/4"	0.0100	50	500
NPD01R	PX00558C	3/4" x 1"	0.0200	25	500
NPD01	PX00578C	1"	0.0200	25	500

NPD07 NPD07R



PEX Poly Elbows

FIGURE NO.	MATERIAL NO.	SIZE	WEIGHT	BAG QTY.	MASTER CTN. QTY.
NPD07	PX00588C	1/2"	0.0100	50	500
NPD07R	PX00598C	3/4" x 1/2"	0.0200	25	250
NPD07	PX00608C	3/4"	0.0200	25	400
NPD07R	PX00612C	1" x 3/4"	0.0370	25	250
NPD07	PX00618C	1"	0.0500	25	250

NPD11 NPD11R



PEX Poly Tees

FIGURE NO.	MATERIAL NO.	SIZE	WEIGHT	BAG QTY.	MASTER CTN. QTY.
NPD11	PX00628C	3/8"	0.0160	25	1,200
NPD11	PX00638C	1/2"	0.0100	50	500
NPD11R	PX00648C	1/2" x 1/2" x 3/4"	0.0200	25	500
NPD11R	PX00658C	3/4" x 1/2" x 1/2"	0.0200	25	300
NPD11R	PX00668C	3/4" x 1/2" x 3/4"	0.0200	25	400
NPD11R	PX00678C	3/4" x 3/4" x 1/2"	0.0200	25	400
NPD11	PX00688C	3/4"	0.0300	25	300
NPD11R	PX00698C	3/4" x 3/4" x 1"	0.0500	25	300
NPD11R	PX00708C	1" x 3/4" x 3/4"	0.0500	25	250
NPD11R	PX00718C	1" x 3/4" "X 1"	0.0500	25	200
NPD11R	PX00728C	1" x 1" x 1/2"	0.0400	25	250
NPD11R	PX00738C	1" x 1" x 3/4"	0.0500	25	250
NPD11	PX00748C	1"	0.0600	25	150

PLUGS

NP18P



PEX Poly Plugs

FIGURE NO.	MATERIAL NO.	SIZE	WEIGHT	BAG QTY.	MASTER CTN. QTY.
NP18P	PX01975C	3/8"	0.0060	20	3,000
NP18P	PX01980	1/2"	0.0060	100	1,000
NP18P	PX01990C	3/4"	0.0130	100	1,000
NP18P	PX01995C	1"	0.1690	25	250

Note: If poly fittings come in contact with glues, chemicals, sealers, or solvents; they should be discarded.

Visit our website for the most current information.

NIBCO® PEX

Plastic Insert Fittings

NPD22 NPD25BE



PEX Male Poly Adapters

FIGURE NO.	MATERIAL NO.	DESCRIPTION	WEIGHT	BAG QTY.	MASTER CTN. QTY.
NPD22	PX01758C	1/2" x 1/2" MIP Poly Adapter	0.0200	50	500
NPD22	PX01768C	3/4" x 3/4" MIP Poly Adapter	0.0200	25	400
NPD22	PX01778C	1/2" x 3/4" MIP Poly Adapter	0.0180	25	700
NPD22	PX01788C	3/4" x 1/2" MIP Poly Adapter	0.0180	25	600
NPD22	PX01798C	1" MIP Poly Adapter	0.0200	25	300

NPD25BE



PEX Male Elbow Poly Adapters

FIGURE NO.	MATERIAL NO.	DESCRIPTION	WEIGHT	BAG QTY.	MASTER CTN. QTY.
NPD25BE	PX01948C	1/2" X 3/8" MIP Poly Adapter Elbow	0.0180	25	900
NPD25BE	PX01958C	1/2" X 1/2" MIP Poly Adapter Elbow	0.0180	50	800
NPD25BE	PX01968C	3/4" x 1/2" MIP Poly Adapter Elbow	0.0180	25	500
NPD25BE	PX01978C	3/4" MIP Poly Adapter Elbow	0.0180	25	400
NPD25BE	PX01988C	1" X 3/4" MIP Poly Adapter Elbow	0.0180	25	500

NPD26 NPD26E



PEX Female Poly Swivel Adapters

FIGURE NO.	MATERIAL NO.	DESCRIPTION	WEIGHT	BAG QTY.	MASTER CTN. QTY.
NPD26	PX01898C	3/4" x 3/4" NPSM Poly Swivel	0.0400	50	500
NPD26	PX02148C	3/8" x 1/2" NPSM Poly Swivel (Faucet)	0.0300	50	600
NPD26	PX01888C	1/2" x 1/2" NPSM Poly Swivel (Faucet)	0.0260	25	500
NPD26C	PX02358C	1/2" x 7/8" NPSM Poly Swivel (Closet/Ballcock)	0.0300	25	400
NPD26E	PX02248C	1/2" x 1/2" NPSM Poly Swivel Elbow (Faucet)	0.0300	10	500
NPD26E	PX02348C	3/4" x 3/4" NPSM Poly Swivel Elbow	0.0300	25	400

Note: If poly fittings come in contact with glues, chemicals, sealers, or solvents; they should be discarded.

Visit our website for the most current information.

NIBCO® PUSH 'N GO®

Fittings

PG01
PG01F
PG01M
PG01RS



Push 'N Go® Couplings

FIGURE NO.	MATERIAL NO.	SIZE	WEIGHT	BAG QTY.	MASTER CTN. QTY.
PG01	PX20100	1/2"	0.0500	10	500
PG01	PX20110	3/4"	0.0950	10	250
PG01M	PX20120	1/2" Male	0.0350	10	600
PG01M	PX20130	3/4" Male	0.0650	10	400
PG01F	PX20140	1/2" Female	0.0500	10	500
PG01F	PX20150	3/4" Female	0.0800	10	300
PG01RS	PX20530	1/2" Stack x 3/8" Reducer	0.0250	10	600
PG01RS	PX20540	3/4" Stack x 1/2" Reducer	0.0400	10	500

PG07, PG07F
PG07M, PG07F
PG035E



Push 'N Go® Elbows

FIGURE NO.	MATERIAL NO.	SIZE	WEIGHT	BAG QTY.	MASTER CTN. QTY.
PG07	PX20200	1/2"	0.0600	10	500
PG07	PX20210	3/4"	0.1100	10	200
PG07M	PX20220	1/2" Male	0.0400	10	500
PG07F	PX20230	1/2" Female	0.0600	10	450
PG35E	PX20240	1/2" Closet Adapter (1/2" x 1/2" x 1/4" OD)	0.0700	10	400

PG11
PG11R



Push 'N Go® Tees

FIGURE NO.	MATERIAL NO.	SIZE	WEIGHT	BAG QTY.	MASTER CTN. QTY.
PG11	PX20000	1/2" x 1/2" x 1/2"	0.0800	10	300
PG11R	PX20020	3/4" x 3/4" x 1/2"	0.1300	10	200
PG11R	PX20010	3/4" x 3/4" x 3/4"	0.1600	10	160
PG11	PX20030	1/2" IceMaker Tee	7.2400	10	300

PG17



Push 'N Go® End Caps

FIGURE NO.	MATERIAL NO.	SIZE	WEIGHT	BAG QTY.	MASTER CTN. QTY.
PG17	PX20500	1/2"	0.0300	10	1,000
PG17	PX20501	3/4"	0.0300	10	500

It is recommended that Push 'N Go® fittings be used only with plastic CTS tubing.

Visit our website for the most current information.

NIBCO® PUSH 'N GO®

Fittings

PG35
PG36
PG36E



Push 'N Go® Adapters

FIGURE NO.	MATERIAL NO.	SIZE	WEIGHT	BAG QTY.	MASTER CTN. QTY.
PG35	PX20300	1/2" Closet	0.0600	10	300
PG36	PX20310	1/2" Garden Hose Adapter	0.0550	10	400
PG36E	PX20320	1/2" Garden Hose Adapter Elbow	0.0650	10	300

PG11S



Push 'N Go® Stack Tees

FIGURE NO.	MATERIAL NO.	SIZE	WEIGHT	BAG QTY.	MASTER CTN. QTY.
PG11S	PX20400	1/2" Tee	0.0700	10	350
PG11S	PX20410	3/4" Tee	0.0450	10	150

PG07S



Push 'N Go® Stack Elbows

FIGURE NO.	MATERIAL NO.	SIZE	WEIGHT	BAG QTY.	MASTER CTN. QTY.
PG07S	PX20420	1/2" Elbow	0.0800	10	350
PG07S	PX20430	3/4" Elbow	0.0800	10	250

PGLC



Push 'N Go® Locking Clips

FIGURE NO.	MATERIAL NO.	SIZE	WEIGHT	BAG QTY.	MASTER CTN. QTY.
PGLC	PX20550	1/4" Icemaker	0.0010	10	1,000
PGLC	PX20560	3/8"	0.0020	100	2,000
PGLC	PX20570	1/2"	0.0020	100	2,000
PGLC	PX20580	3/4"	0.0020	100	3,000
PGLC	PX20590	1"	0.0020	100	3,000

PGV
PG97



Push 'N Go® Miscellaneous

FIGURE NO.	MATERIAL NO.	SIZE	WEIGHT	BAG QTY.	MASTER CTN. QTY.
PGV	PX20510	1/2" In-Line Valve	0.1050	10	200
PG97	PX20520	1/2" In-Line Union	0.0500	10	300

It is recommended that Push 'N Go® fittings be used only with plastic CTS tubing.

Visit our website for the most current information.

NIBCO® PEX

Connections (Crimp, Sleeve, Clamp)

CONNECTIONS

NP19



PEX Copper Crimp Rings

FIGURE NO.	MATERIAL NO.	DESCRIPTION	WEIGHT	BAG QTY.	MASTER CTN. QTY.
NP19	PX80905	3/8" Copper Crimp Ring (black)	0.0110	25	250
NP19	PX80915	1/2" Copper Crimp Ring (black)	0.0130	100	1,000
NP19	PX80925	3/4" Copper Crimp Ring (black)	0.0170	50	500
NP19	PX80935	1" Copper Crimp Ring (black)	0.0220	50	250
NP19	PX80945	1-1/4" Copper Crimp Ring (black)	0.2530	25	250

NP19CS



PEX Copper Crimp Sleeves

FIGURE NO.	MATERIAL NO.	DESCRIPTION	WEIGHT	BAG QTY.	MASTER CTN. QTY.
NP19CS	PX80911	1/2" Copper Crimp Sleeve	0.019	50	600
NP19CS	PX80921	3/4" Copper Crimp Sleeve	0.028	50	500
NP19CS	PX80931	1" Copper Crimp Sleeve	0.031	50	250

NP50



PEX Stainless Steel Sleeves

FIGURE NO.	MATERIAL NO.	DESCRIPTION	WEIGHT	BAG QTY.	MASTER CTN. QTY.
NP50	PX02110	1/2" SS PEX Sleeve	0.0060	50	5,000
NP50	PX02120	3/4" SS PEX Sleeve	0.0100	50	2,500
NP50	PX02130	1" SS PEX Sleeve	0.0100	50	2,500

Visit our website for the most current information.

NIBCO® PEX
Home Run Manifolds

6-Port and 12-Port Manifolds - Lead Free*
1" CTS Trunk, 3/4" and 1" End Connections, 1/2" Ports



All manifolds (except bulk models) come with:

- Mounting clip(s) and screws
- Hot and cold label sheets
- Mounting template
- Instructions



6-Port



12-Port

FIGURE NO.	MATERIAL NO.	DESCRIPTION	TRUNK JOINTS		VALVES 1/2"	LENGTH	DIMENSIONS	
			END 1	END 2			WIDTH	HEIGHT
PM6-A	PX90002	6-Port Manifold	None	None	No	16"	3"	1-1/8"
PM6-LF	PX90003E	6-Port Manifold	1" PEX	1" Plug	No	17-1/4"	3"	1-1/8"
PM6-LF	PX90004E	6-Port Manifold	3/4" PEX	1" Plug	No	17-1/8"	3"	1-1/8"
PM6-V1-LF	PX90005E	6-Port Manifold w/Valves	1" PEX	1" Plug	6	17-1/4"	3"	1-1/8"
PM6-V1-LF	PX90006E	6-Port Manifold w/Valves	3/4" PEX	1" Plug	6	17-1/8"	3"	1-1/8"
PM6-B	PX90069	6-Port Manifold - Bulk	None	None	No	16"	3"	1-1/8"
PM6-P-LF	PX90067E	6-Port Manifold - 1" Plug Ends	1" Plug	1" Plug	No	16"	3"	1-1/8"
PM12-LF	PX90007E	12-Port Manifold	1" PEX	1" Plug	No	34-3/8"	3"	1-1/8"
PM12-LF	PX90008E	12-Port Manifold	3/4" PEX	1" Plug	No	33-7/8"	3"	1-1/8"
PM12-V1-LF	PX90009E	12-Port Manifold w/Valves	1" PEX	1" Plug	12	34-3/8"	3"	1-1/8"
PM12-V1-LF	PX90010E	12-Port Manifold w/Valves	3/4" PEX	1" Plug	12	33-7/8"	3"	1-1/8"
PM12-P-LF	PX90068E	12-Port Manifold - 1" Plug Ends	1" Plug	1" Plug	No	34-3/8"	3"	1-1/8"

*Weighted average lead content ≤ 0.25%

Visit our website for the most current information.

NIBCO® PEX

Home Run Manifolds



8-Port and 16-Port Manifolds - Lead Free*

1 1/4" CTS Trunk, 3/4", 1" and 1-1/4" End Connections, 1/2" Ports

V1 Models - 1/2" Valves

All manifolds (except bulk models) come with:

- Mounting clip(s) and screws
- Hot and cold label sheets
- Mounting template
- Instructions



8-Port



16-Port

FIGURE NO.	MATERIAL NO.	DESCRIPTION	TRUNK JOINTS		VALVES 1/2"	LENGTH	DIMENSIONS	
			END 1	END 2			WIDTH	HEIGHT
PH8-A	PX90011	8-Port Manifold	None	None	No	9-1/8"	5"	1-3/8"
PH8-LF	PX90012E	8-Port Manifold	1-1/4" PEX	1-1/4" Plug	No	10-1/2"	5"	1-3/8"
PH8-LF	PX90013E	8-Port Manifold	1" PEX	1-1/4" Plug	No	10-1/4"	5"	1-3/8"
PH8-LF	PX90014E	8-Port Manifold	3/4" PEX	1-1/4" Plug	No	10-1/8"	5"	1-3/8"
PH8-V1-LF	PX90015E	8-Port Manifold w/valves	1-1/4" PEX	1-1/4" Plug	8	10-1/2"	5"	1-3/8"
PH8-V1-LF	PX90016E	8-Port Manifold w/valves	1" PEX	1-1/4" Plug	8	10-1/4"	5"	1-3/8"
PH8-V1-LF	PX90017E	8-Port Manifold w/valves	3/4" PEX	1-1/4" Plug	8	10-1/8"	5"	1-3/8"
PH16-A	PX90021	16-Port Manifold	None	None	No	18-1/4"	5"	1-3/8"
PH16-LF	PX90022E	16-Port Manifold	1-1/4" PEX	1-1/4" Plug	No	20-1/2"	5"	1-3/8"
PH16-LF	PX90023E	16-Port Manifold	1" PEX	1-1/4" Plug	No	20-1/4"	5"	1-3/8"
PH16-LF	PX90024E	16-Port Manifold	3/4" PEX	1-1/4" Plug	No	20-1/8"	5"	1-3/8"
PH16-LF	PX90088E	16-Port Manifold 1" FIP	1" FIP Adpt	1-1/4" Plug	No	20-1/4"	5"	1-3/8"
PH16-V1-LF	PX90025E	16-Port Manifold w/valves	1-1/4" PEX	1-1/4" Plug	16	20-1/2"	5"	1-3/8"
PH16-V1-LF	PX90026E	16-Port Manifold w/valves	1" PEX	1-1/4" Plug	16	20-1/4"	5"	1-3/8"
PH16-V1-LF	PX90027E	16-Port Manifold w/valves	3/4" PEX	1-1/4" Plug	16	20-1/8"	5"	1-3/8"

*Weighted average lead content ≤ 0.25%

Visit our website for the most current information.

NIBCO® PEX

Home Run Manifolds

16, 24, 32 and 40-Port Dual Temperature Manifolds - Lead Free*

1 1/4" CTS Trunk, 3/4", 1" and 1-1/4" End Connections, 1/2" Ports

V1 Models - 1/2" Valves

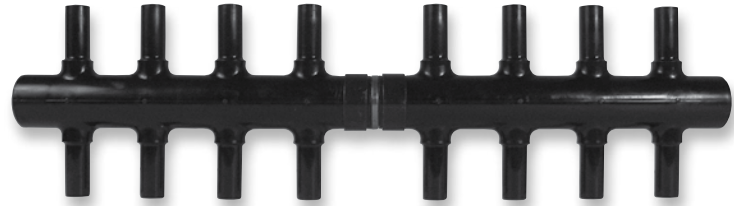

16-Port Dual Temperature



All manifolds (except bulk models) come with:

- Mounting clip(s) and screws
- Hot and cold label sheets
- Mounting template
- Instructions

Manifold Size	Side A	Side B
16-Port	8	8
24-Port	16	8
32-Port	16	16
40-Port	24	16

FIGURE NO.	MATERIAL NO.	DESCRIPTION	TRUNK JOINTS		VALVES 1/2"	LENGTH	DIMENSIONS	
			END 1	END 2			WIDTH	HEIGHT
PH16D-LF	PX90031E	16-Port DUAL TEMP	1-1/4" PEX	1-1/4" PEX	No	20-1/2"	5"	1-3/8"
PH16D-LF	PX90032E	16-Port DUAL TEMP	1" PEX	1" PEX	No	20-1/4"	5"	1-3/8"
PH16D-LF	PX90033E	16-Port DUAL TEMP	3/4" PEX	3/4" PEX	No	20"	5"	1-3/8"
PH16D-V1-LF	PX90034E	16-Port DUAL TEMP w/valves	1-1/4" PEX	1-1/4" PEX	16	20-1/2"	5"	1-3/8"
PH16D-V1-LF	PX90035E	16-Port DUAL TEMP w/valves	1" PEX	1" PEX	16	20-1/4"	5"	1-3/8"
PH16D-V1-LF	PX90036E	16-Port DUAL TEMP w/valves	3/4" PEX	3/4" PEX	16	20"	5"	1-3/8"
PH24D-LF	PX90040E	24-Port DUAL TEMP	1-1/4" PEX	1-1/4" PEX	No	29-1/2"	5"	1-3/8"
PH24D-LF	PX90041E	24-Port DUAL TEMP	1" PEX	1" PEX	No	29-1/8"	5"	1-3/8"
PH24D-LF	PX90042E	24-Port DUAL TEMP	3/4" PEX	3/4" PEX	No	28-3/4"	5"	1-3/8"
PH24D-V1-LF	PX90043E	24-Port DUAL TEMP w/valves	1-1/4" PEX	1-1/4" PEX	24	29-1/2"	5"	1-3/8"
PH24D-V1-LF	PX90044E	24-Port DUAL TEMP w/valves	1" PEX	1" PEX	24	29-1/8"	5"	1-3/8"
PH24D-V1-LF	PX90045E	24-Port DUAL TEMP w/valves	3/4" PEX	3/4" PEX	24	28-3/4"	5"	1-3/8"
PH32D-LF	PX90049E	32-Port DUAL TEMP	1-1/4" PEX	1-1/4" PEX	No	38-3/4"	5"	1-3/8"
PH32D-LF	PX90050E	32-Port DUAL TEMP	1" PEX	1" PEX	No	38-1/2"	5"	1-3/8"
PH32D-LF	PX90051E	32-Port DUAL TEMP	3/4" PEX	3/4" PEX	No	38-1/8"	5"	1-3/8"
PH32D-V1-LF	PX90052E	32-Port DUAL TEMP w/valves	1-1/4" PEX	1-1/4" PEX	32	38-3/4"	5"	1-3/8"
PH32D-V1-LF	PX90053E	32-Port DUAL TEMP w/valves	1" PEX	1" PEX	32	38-1/2"	5"	1-3/8"
PH32D-V1-LF	PX90054E	32-Port DUAL TEMP w/valves	3/4" PEX	3/4" PEX	32	38-1/8"	5"	1-3/8"
PH40D-LF	PX90058E	40-Port DUAL TEMP	1-1/4" PEX	1-1/4" PEX	No	48"	5"	1-3/8"
PH40D-LF	PX90059E	40-Port DUAL TEMP	1" PEX	1" PEX	No	47-3/4"	5"	1-3/8"
PH40D-LF	PX90060E	40-Port DUAL TEMP	3/4" PEX	3/4" PEX	No	47-3/8"	5"	1-3/8"
PH40D-V1-LF	PX90061E	40-Port DUAL TEMP w/valves	1-1/4" PEX	1-1/4" PEX	40	48"	5"	1-3/8"
PH40D-V1-LF	PX90062E	40-Port DUAL TEMP w/valves	1" PEX	1" PEX	40	47-3/4"	5"	1-3/8"
PH40D-V1-LF	PX90063E	40-Port DUAL TEMP w/valves	3/4" PEX	3/4" PEX	40	47-3/8"	5"	1-3/8"

*Weighted average lead content ≤ 0.25%

Visit our website for the most current information.

NIBCO® PEX

Home Run & Copper Manifolds

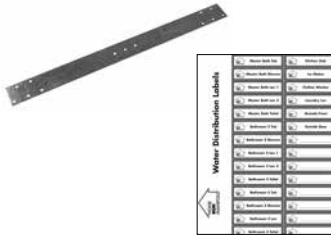

PEX Home Run Manifold® Accessories

FIGURE NO.	MATERIAL NO.	DESCRIPTION	WEIGHT	BOX QTY.	MASTER CTN. QTY.
PMLC	PX90072	Home Run Manifold Sheet of ID Labels - COLD	0.0030	100	1000
PMLH	PX90073	Home Run Manifold Sheet of ID Labels - HOT	0.0030	100	1000
PHSTRAP	PX90080	PH Manifold Stud Strap	0.0550	50	500
NP42	PX90077	Mounting Clip for 1" Trunk	0.0100	—	400
NP42	PX90078	Mounting Clip for 1-1/4" Trunk	0.0190	—	400
NP200	PX14151	Access Panel 14" x 29"	4.1500	1	10
NP200	PX14152	Access Panel 14" x 38"	4.3600	1	10

COPPER MANIFOLDS

NP203, NP203C
NP204, NP205,
NP205C, NP206C
NP208, NP208C

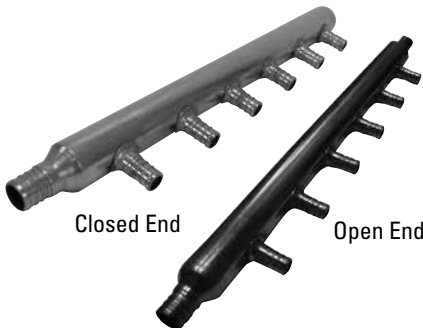

PEX Branch Manifolds

FIGURE NO.	MATERIAL NO.	DESCRIPTION	WEIGHT	BOX QTY.	MASTER CTN. QTY.
NP203	PX01000	3 Br Cp Manifold Open 3/4" x 1/2" Out	0.5120	—	25
NP203C	PX01009	3 Br Cp Manifold Closed 3/4" x 1/2" Out	0.4520	—	25
NP204	PX01012	4 Br Cp Manifold Open 3/4" x 1/2" Out	0.5600	—	25
NP204C	PX01013	4 Br Cp Manifold Closed 3/4" x 1/2" Out	0.6580	—	25
NP205	PX01014	5 Br Cp Manifold Open 3/4" x 1/2" Out	0.7120	—	25
NP205C	PX01015	5 Br Cp Manifold Closed 3/4" x 1/2" Out	0.6800	—	25
NP206C	PX01018	6 Br Cp Manifold Closed 3/4" x 1/2" Out	0.8960	—	25
NP208	PX01022	8 Br Cp Manifold Open 3/4" x 1/2" Out	1.0080	—	25



PEX Manifold Bracket

FIGURE NO.	MATERIAL NO.	DESCRIPTION	WEIGHT	BOX QTY.	MASTER CTN. QTY.
11555	PX10299	Manifold Bracket	0.5000	1	10

NP204V, NP204VC
NP205V, NP205VC
NP206V, NP206VC

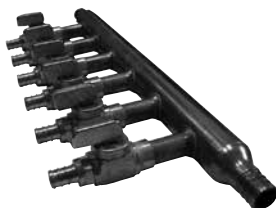

PEX Valve Manifolds

FIGURE NO.	MATERIAL NO.	DESCRIPTION	WEIGHT	BOX QTY.	MASTER CTN. QTY.
NP203V	PX01027	3 Br 1" Manifold F x M Swt w/Valves	1.6000	1	10
NP205V	PX01029	5 Br 1" Manifold F x M Swt w/Valves	2.3000	1	10
NP204V	PX01130	4 Br Manifold w/Valve Open 3/4" x 3/4" x 1/2" Out	1.8460	1	10
NP204VC	PX01100	4 Br Manifold w/Valve Closed 3/4" x 1/2" Out	1.8040	1	10

Visit our website for the most current information.

NIBCO® PEX

Valves

VALVES

PXCP400-LF, NPR50A-LF



PEX Lead-Free* Ball Valves

FIGURE NO.	MATERIAL NO.	DESCRIPTION	WEIGHT	BAG QTY.	MASTER CTN. QTY.
PXCP400-LF	PX01526X	1/2" PEX Brass Ball Valve w/ LH	0.2500	18	18
PXCP400-LF	PX01546X	3/4" PEX Brass Ball Valve w /LH	0.4100	12	12
PXCP400-LF	PX01566X	1" PEX Brass Ball Valve w/ LH	0.5700	6	6
NPR50A-LF	PX10297E	1/2" PEX Mini Brass Ball Valve	0.1500	20	200

PEX Straight Stop Valves



FIGURE NO.	MATERIAL NO.	DESCRIPTION	WEIGHT	BAG QTY.	MASTER CTN. QTY.
NP7160-LF	ND615L8	1/2" PEX x 1/4" OD (Icemaker) Straight Stop	0.1530		5
7160-LF	ND618L6	Straight Supply Stop 1/2" PEX x 3/8" OD	0.1520		10
7160PEX-LF	ND618L7	Straight Supply Stop 1/2" PEX x 1/2" PEX	0.1340		10
7160M-LF	ND618L5	1/2" PEX x 1/2" Male Straight Supply Stop	0.1590		10

PEX Angle Stop Valves



FIGURE NO.	MATERIAL NO.	DESCRIPTION	WEIGHT	BAG QTY.	MASTER CTN. QTY.
7165-LF	ND615L9	1/2" PEX x 1/4" OD (Icemaker) Angle Supply Stop	0.1650		5
7165-LF	ND619L6	Angle Supply Stop 1/2" PEX x 3/8" OD	0.1640		10
7165PEX-LF	ND619L7	1/2" PEX x PEX Angle Stop	0.1480	5	

PEX Other Valves



FIGURE NO.	MATERIAL NO.	DESCRIPTION	WEIGHT	BAG QTY.	MASTER CTN. QTY.
NP7170	PX01521E	1/2" PEX x Hose Thread Valve	0.1500	10	150

*Weighted average lead content ≤ 0.25%

Visit our website for the most current information.

NIBCO® PEX
Radiant Heating

NIBCO® PEX
RADIANT SYSTEMS

Radiant Manifolds and Accessories

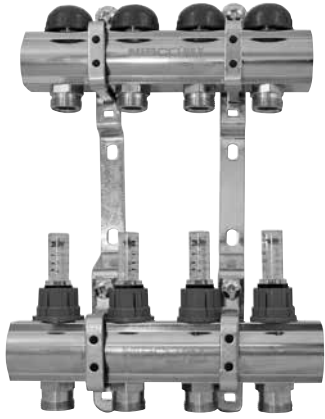

Radiant Heat Manifold

FIGURE NO.	MATERIAL NO.	DESCRIPTION	WEIGHT	BOX QTY.
NR1	PX10502	NR 2 PORT 1" Radiant Heat Manifold	7.7000	1
NR1	PX10503	NR 3 PORT 1" Radiant Heat Manifold	8.9500	1
NR1	PX10504	NR 4 PORT 1" Radiant Heat Manifold	11.1600	1
NR1	PX10505	NR 5 PORT 1" Radiant Heat Manifold	12.3700	1
NR1	PX10506	NR 6 PORT 1" Radiant Heat Manifold	13.8000	1
NR1	PX10507	NR 7 PORT 1" Radiant Heat Manifold	14.7000	1
NR1	PX10508	NR 8 PORT 1" Radiant Heat Manifold	15.6700	1
NR1	PX10509	NR 9 PORT 1" Radiant Heat Manifold	18.2100	1
NR1	PX10510	NR 10 PORT 1" Radiant Heat Manifold	20.1700	1
NR1	PX10541	NR Valve Set for Manifold 1" FIP Straight	3.1700	1
NR1	PX10542	NR Valve Set for Manifold 1" FIP Angle	2.9420	1
NR1	PX10552	NR Manifold 1/2" PEX Connector	0.1280	10
NR1	PX10554	NR Manifold 5/8" PEX Connector	0.1280	10
NR1	PX10546	NR Fill & Purge Set w/ Air Vents	1.2800	1
NR1	PX10548	NR Actuator 24VAC NC - 2 Wire	0.3200	1



**FIP Valve Set
Straight**
2 per set



**FIP Valve Set
Angle**
2 per set



**Fill & Purge Set
w/Air Vents**
2 per set



Actuator



PEX Connector

Visit our website for the most current information.

NIBCO® PEX
Radiant Heating

NIBCO PEX
RADIANT SYSTEMS

NPRHP
NPR180C
NPR90HP2T



PEX Radiant Heat Panels

FIGURE NO.	MATERIAL NO.	DESCRIPTION	WEIGHT	BAG QTY.	MASTER CTN. QTY.
NPRHP	PX10231	RHP Radiant Heat Panel	11.8000	1	1
NPRHP	PX10232	RHP-1 Radiant Heat Panel	18.4000	1	1
NPRHP	PX10233	RHP-2 Radiant Heat Panel	22.4000	1	1
NPRHP	PX10234	RHP-2-4 Radiant Heat Panel	25.6500	1	1
NPRHP	PX10235	RHP 3 Radiant Heat Panel	43.0500	1	1
NPR180C	PX10246	Zone Kit For RHP 2-4	1.7000	1	1
NPR90HP2T	PX10247	Radiant Heat Panel - Tankless	23.0000	1	1

Parts & Accessories for Panels

FIGURE NO.	MATERIAL NO.	DESCRIPTION	WEIGHT	BAG QTY.	MASTER CTN. QTY.
NPR310ZV	PX10306	3/4" NPT Zone Valve w/ Union	.950	1	10
NPR315A	PX10308	Actuator 24V For Zone Valve	.330	1	10
NPR285TW	PX10312	FH Thermostat w/ Floor Sensor	.350	1	10
NPR285T	PX10313	FH Thermostat Only	.112	1	25
NPR290TW	PX10314	Floor Sensor	.080	1	25

NPR230PMV
NPR240PMV
NPR250PMV
NPR260PMV
NPR211C

PEX Radiant Pumps

FIGURE NO.	MATERIAL NO.	DESCRIPTION	WEIGHT	BAG QTY.	MASTER CTN. QTY.
NPR230PMV	PX10289	Grundfos® 1558 3-Speed Bronze Pump Union Connection	3.7800	1	1
NPR194GP	PX10344	Pump Connection Kit Sweat or PEX for PX10289	0.0100	1	10

Visit our website for the most current information.

NIBCO® PEX
Radiant Heating

NIBCO® PEX
RADIANT SYSTEMS

NPR120TP



Heat Transfer Plates

FIGURE NO.	MATERIAL NO.	DESCRIPTION	WEIGHT	BAG QTY.	MASTER CTN. QTY.
NPR120TP	PX10251	Rad-Trax™ Easy Install Heat Transfer Plate	1.7000	1	20

NPR10A, 11032



PEX Radiant Accessories

FIGURE NO.	MATERIAL NO.	DESCRIPTION	WEIGHT	BOX QTY.	MASTER CTN. QTY.
NPR10A	PX10296	Thermometer, Strap On	0.2500	1	25
11032	PX10300R	Radiant DVD/CD-ROM	0.3000	30	60
NPPP	PX10328	PEX-Pal Tube Holder	0.6560		40
NPPPEP	PX10329	PEX-Pal End Plate	0.1480		10

NPR145C, NPR150C
NPR160C, NPR170C
NPR305FC
NPR305WMC



PEX Radiant PEX Clips

FIGURE NO.	MATERIAL NO.	DESCRIPTION	WEIGHT	BAG QTY.	MASTER CTN. QTY.
NPR170C	PX10271	1/2" PEX Clips (Legacy)	0.0100	100	10,000
NPR170C	PX10272	3/4" PEX Clips (Legacy)	0.3500	100	10,000
NPR145C	PX10273	Reddi-Strip®* Stand Up Staple Gun	10.9500	1	1
NPR150C	PX10274	Reddi-Strip®* Staples - Box of 200	0.6500	1	50
NPR305FC	PX71250	1/2" PEX Clips for Styrofoam	0.0080	25	1,600
NPR305WMC	PX71251	1/2" PEX Clips for Wire Mesh	0.0160	25	1,000

* Reddi-Strip® is a registered trademark of Peter Mangone, Inc.

Visit our website for the most current information.

NIBCO® PEX Tools

NP32C NP32S



PEX Crimp Tools - Compact

FIGURE NO.	MATERIAL NO.	DESCRIPTION	WEIGHT	BAG QTY.	MASTER CTN. QTY.
NP32C	PX02505	3/8" Compact Crimp Tool w/gauge (12")	2.1000	1	20
NP32C	PX02515	1/2" Compact Crimp Tool w/gauge (12")	2.0500	1	10
NP32S	PX02540	3/4" Compact Crimp Tool w/gauge(12")	2.000	1	10
NP32S	PX02530	1/2" Compact Crimp Tool	2.0000	1	10

NP32CH NP32LH



PEX Crimp Tools - Standard

FIGURE NO.	MATERIAL NO.	DESCRIPTION	WEIGHT	BAG QTY.	MASTER CTN. QTY.
NP32CH	PX02529	Standard 3/8" PEX Crimp Tool	3.0000	1	10
NP32CH	PX02532	Standard 1/2" PEX Crimp Tool	3.0000	1	10
NP32CH	PX02531	Standard 3/4" PEX Crimp Tool	3.0000	1	10
NP32CH	PX02533	Standard 1" PEX Crimp Tool	3.2500	1	10
NP32LH	PX02545	1-1/4" Long Handle Crimp Tool w/gauge (19")	6.0000	1	10

NP32B NP33C



PEX Crimp Tools - Economy & Combo

FIGURE NO.	MATERIAL NO.	DESCRIPTION	WEIGHT	BAG QTY.	MASTER CTN. QTY.
NP32B	PX02555	1/2" & 3/4" Block Combo Crimp Tool	0.8500	1	50
NP32B	PX02565	3/8" & 1" Block Combo Crimp Tool	0.9000	10	40
NP33C4IN1	PX01385	3/8", 1/2", 3/4", 1" Block Tool w/gauge	1.1500	1	50
NP32MH	PX02585	1/2" & 3/4" Combo Mid-Handle Crimp Tool	3.4000	1	12
NP33C	PX01340	Combo 1/2" & 3/4" PEX Crimp Tool (12")	4.0000	1	10

NP52 NP52C



PEX Sleeve Tools

FIGURE NO.	MATERIAL NO.	DESCRIPTION	WEIGHT	BAG QTY.	MASTER CTN. QTY.
NP52	PX01364C	1/2" PEX Sleeve Tool (12")	3.1000	1	16
NP52C	PX01365	1/2" Compact PEX Sleeve Tool	2.0000	1	10
NP52	PX01366	3/4" PEX Sleeve Tool (12")	4.0000	1	16
NP52	PX01368	1" PEX Sleeve Tool (12")	4.5000	1	12

Visit our website for the most current information.

NIBCO® PEX

Tools

NP32DC



PEX Other Tools & Accessories

FIGURE NO.	MATERIAL NO.	DESCRIPTION	WEIGHT	BAG QTY.	MASTER CTN. QTY.
NP32DC	PX02575	Decrimping Tool For All Size Rings	0.6000	1	50
NP34	PX01380	1" Go/No Go Gauge	0.2000	1	50
NP34	PX01381	1-1/4" Go/No Go Gauge	0.1000	1	
NP35	PX01360	1/2" - 3/4" PEX Easy Cut Tool	0.3000	1	50
NP35	PX01390	3/8" - 1-1/4" Pipe Cutter	0.3400	1	50
NP37	PX01415	Tube Uncoiler	35.4000	1	1

NP34



NP35



NP37

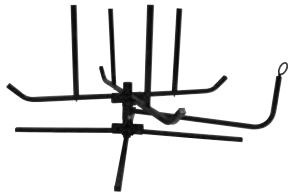

Visit our website for the most current information.

NIBCO® PEX

Mini Pressing Tool and Crimp Jaws



PC-20M



PCX-200M



**PCX-1M
PCX-2M
PCX-3M
PCX-6M
PCX-7M**

PEX PC-20M Mini Pressing Tool & Crimp Jaws

FIGURE NO.	MATERIAL NO.	DESCRIPTION	WEIGHT	BOX QTY.
PC-20M	R00205PC	Mini Pressing Tool, 2 - 18V, 1.3 Ah Lithium-ion batteries, 110V charger & case (NO jaws)	17.20	1
PCX-200M	R00205PCX	Mini Pressing Tool, 3 Crimp Jaws (1/2", 3/4" & 1"), 1/2", 3/4", & 1" Gauge, 2 - 18V, 1.3 Ah Lithium-ion batteries, 110V charger & case	18.05	1
PCX-1M	R00215PCX	1/2" Crimp Jaw for PC-20M and PC-10M (Includes 1/2", 3/4", & 1" Gauge)	2.94	1
PCX-6M	R00240PCX	5/8" Crimp Jaw for PC-20M and PC-10M (Includes 5/8", 1-1/4" Gauge)	2.97	1
PCX-2M	R00220PCX	3/4" Crimp Jaw for PC-20M and PC-10M (Includes 1/2", 3/4", & 1" Gauge)	2.90	1
PCX-3M	R00230PCX	1" Crimp Jaw for PC-20M and PC-10M (Includes 1/2", 3/4", & 1" Gauge)	2.92	1
PCX-7M	R00250PCX	1-1/4" Crimp Jaw for PC-20M and PC-10M (Includes 5/8", 1-1/4" Gauge)	3.11	1
PC-4ML	R00245PC	18V, 1.3Ah Lithium-ion Battery for PC-20M	0.80	1
PC-7L	R00175PC	18V, 3.0Ah Lithium-ion Battery for PC-20M	1.30	1
PC-8L	R00187PC	110V Battery Charger for PC-4ML and PC-7L	2.20	1
PC-9L	R00195PC	AC Adapter for PC-20M	1.70	1
PC-4M	R00240PC	1.3 Ah NiCd 9.6V Battery for PC-10M	1.85	1
PC-5M	R00250PC	120V Charger for PC-10M	1.13	1
NP34	PX01388	Go/No Go Crimp Gauge (1/2", 3/4", 1")	0.85	1
NP34	PX01389	Go/No Go Crimp Gauge (5/8", 1-1/4")	0.85	1



PC-7L
18V, 3.0 Ah
Lithium-ion Battery



PC-8L
110V Battery Charger



PC-4M
9.6V, 1.3 Ah NiMH Battery



PC-4ML
18V, 1.3 Ah
Lithium-ion Battery



PC-9L
AC Adapter



PC-5M
120V Battery Charger

Visit our website for the most current information.

NIBCO® PEX

Installation Accessories

NP38



PEX Tube Talon

FIGURE NO.	MATERIAL NO.	DESCRIPTION	WEIGHT	BOX QTY.	MASTER CTN. QTY.
NP38	PX02000	3/8" CTS Tube Talon w/Nail	0.0080	100	1,000
NP38	PX02010	1/2" CTS Tube Talon w/Nail	0.0110	100	1,000
NP38	PX02020	3/4" CTS Tube Talon w/Nail	0.0160	100	1,000
NP38	PX02030	1" CTS Tube Talon w/Nail	0.0240	50	500

NP39



PEX Insulator Clamps

FIGURE NO.	MATERIAL NO.	DESCRIPTION	WEIGHT	BOX QTY.	MASTER CTN. QTY.
NP39	PX02040	3/8" Tubing Insulator Clamp	0.0210	50	500
NP39	PX02050	1/2" Tubing Insulator Clamp	0.0230	50	500
NP39	PX02060	3/4" Tubing Insulator Clamp	0.0190	50	500
NP39	PX02070	1" Tubing Insulator Clamp	0.0170	25	250

NP40, NP40N NP40P



Plastic Bend Support



Metal Bend Support

PEX Bend Supports

FIGURE NO.	MATERIAL NO.	DESCRIPTION	WEIGHT	BOX QTY.	MASTER CTN. QTY.
NP40	PX02080	1/2" CTS PEX Metal Bend Support	0.1010	50	50
NP40P	PX02083	1/2" PEX Plastic Bend Support	0.0800	25	250
NP40P	PX02084	3/4" PEX Plastic Bend Support	0.1600	10	80
NP40P	PX02086	1" PEX Plastic Support Bend	0.2600	5	50

Visit our website for the most current information.

25
years

NIBCO INC. LIMITED WARRANTY

Applicable to NIBCO INC. PEX Piping Systems

NIBCO INC. warrants that when NIBCO® PEX tube is used with NIBCO® PEX fittings, and NIBCO® valves and installation accessories, they will, under normal conditions, use and service in potable water and radiant heat systems, be free from defects in materials and workmanship for a period of twenty-five (25) years from the date of purchase when installed by a licensed professional contractor. This 25-year warranty is voided if any non-NIBCO products are used in the PEX system. NIBCO INC. warrants NIBCO PEX tube, when used under normal conditions, use and service in potable water and radiant heat systems with brass insert fittings meeting NSF/ANSI 61, ASTM F1807 and ASTM F877 to be free from defects in materials and workmanship for a period of ten (10) years from the date of purchase. NIBCO INC. warrants NIBCO® PEX fittings, manifolds, transition fittings and valves under normal conditions, use and service in potable water and radiant heat systems, to be free from defects in materials and workmanship for a period of ten (10) years from the date of purchase. NIBCO INC. warrants NIBCO® associated hardware and tools for a period of 90 days from the date of purchase.

In the event any defect occurs which the owner believes is covered by this warranty, the owner should immediately contact NIBCO Technical Services, either in writing or by telephone at 1.888.446.4226 or 1.574.295.3000. The owner will be instructed to return said tube, fittings or accessories, at the owner's expense, to NIBCO INC., or an authorized representative for inspection. In the event said inspection discloses to the satisfaction of NIBCO INC. that said tube, fitting or accessory is defective, a replacement shall be mailed free of charge to the owner.

IN ORDER FOR THIS LIMITED WARRANTY TO APPLY, THE ABOVE REFERENCED PRODUCTS MUST BE INSTALLED BY A LICENSED PROFESSIONAL PLUMBER IN ACCORDANCE WITH NIBCO INSTALLATION INSTRUCTIONS AND IN COMPLIANCE WITH ALL APPLICABLE CODE REQUIREMENTS. FAILURE TO DO SO WILL VOID ALL APPLICABLE WARRANTIES.

This warranty does not apply and you do not have a right of reimbursement if the failure or resulting damage is caused by:

1. breaks, tearing, kinking, gouges, punctures or other external damages before, during, or after installation;
2. exposure to temperatures and pressures beyond the product ratings as specified on the product or in the NIBCO installation manual;
3. exposure to damaging chemicals, substances or corrosive water conditions;
4. damage from abnormal operating conditions;
5. damage due to accident, abuse, misuse, or unauthorized modification or repair;
6. improper installation due to worn, damaged, unauthorized or improperly calibrated tools;
7. components in the plumbing system other than those manufactured or sold by NIBCO;
8. not designing, installing, inspecting or testing the system in accordance with NIBCO installation instructions at the time of the installation; or
9. failure to follow applicable code requirements and good plumbing practices.

TO THE EXTENT PERMITTED BY LAW, THIS WARRANTY SPECIFICALLY EXCLUDES INCIDENTAL AND CONSEQUENTIAL DAMAGES OF EVERY TYPE AND DESCRIPTION RESULTING FROM ANY CLAIMED DEFECT IN MATERIAL OR WORKMANSHIP, INCLUDING BUT NOT LIMITED TO, PERSONAL INJURIES AND PROPERTY DAMAGES.

Some states or countries do not allow the exclusion or limitation of incidental or consequential damages so these limitations may not apply to you.

TO THE EXTENT PERMITTED BY LAW, IMPLIED WARRANTIES OF MERCHANTABILITY AND FITNESS FOR A PARTICULAR PURPOSE ARE LIMITED IN DURATION.

This warranty gives you specific legal rights, and you may also have other rights which vary from state to state and country to country.



To the best of our knowledge, the information contained in this publication is accurate. However, NIBCO does not assume any liability whatsoever for the accuracy or completeness of such information. Final determinations of the suitability of any information or product for the use to be contemplated is the sole responsibility of the user. The manner of that use, and whether there is any infringement of patents, is also the sole responsibility of the user.

Visit our website for the most current information.

globally connecting you at all levels



It's a new age of business, and a new way at NIBCO. From Elkhart, Indiana to Lodz, Poland, and points beyond, our company has integrated manufacturing, distribution, and networked communications to provide a seamless source of information and service, 24 hours a day, 7 days a week. But this integration hasn't happened overnight. It's been part of a long-term strategic process that has pushed us to reconsider every aspect of our business. The result? We're a vertically integrated manufacturer with the products and systems in place to deliver low cost and high quality. NIBCO products are manufactured under a Quality Management System conforming to the current revision of ISO-9001 International Standards. We know the flow control industry is only going to get more demanding, and we are more than ready. We will continue to lead. That's what NIBCO is all about.



NIBCO® PEX Piping Systems • NIBCO® Press System®

FITTINGS

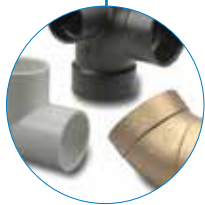

Wrot and cast copper pressure and drainage fittings • Cast copper alloy flanges
 • Wrot and cast press fittings • ABS and PVC DWV fittings • Schedule 40 PVC
 pressure fittings • CPVC CTS fittings • CPVC CTS-to-metal transition fittings
 • Schedule 80 PVC and CPVC systems • CPVC metric piping systems
 • CPVC BlazeMaster® fire protection fittings • Lead-Free* fittings

BlazeMaster® is a registered trademark of The Lubrizol Corporation.
 *Weighted average lead content ≤0.25%

VALVES & ACTUATION

Pressure-rated bronze, iron and alloy-iron gate, globe and check valves • Pressure-
 rated bronze ball valves • Boiler specialty valves • Commercial and industrial
 butterfly valves • Circuit balancing valves • Carbon and stainless steel ball valves
 • ANSI flanged steel ball valves • Pneumatic and electric actuators and controls
 • Grooved ball and butterfly valves • High performance butterfly valves • UL/FM
 fire protection valves • MSS specification valves • Bronze specialty valves • Low
 pressure gate, globe, check and ball valves • Frostproof sillcocks • Quarter-turn
 supply stops • Quarter-turn low pressure valves • PVC ball valves • CPVC
 CTS ball valves • Bronze & Iron Y-Strainers • Lead-Free* valves • Coil-
 Connect™ Kits

*Weighted average lead content ≤0.25%



CHEMTROL®



Thermoplastic pipe, valves and fittings in PVC, Corzan® CPVC, polypropylene
 and PVDF Kynar® • Pneumatic and electric actuation systems

Corzan® is a registered trademark of The Lubrizol Corporation. • Kynar® is a registered trademark of Arkema Inc.

eNIBCO

EDI—Electronic Data Interchange • VMI—Vendor Managed Inventory
 • NIBCO.com • NIBCOpartner.com



NIBCO®
 AHEAD OF THE FLOW®

NIBCO INC.
WORLD HEADQUARTERS
 WEB: www.nibco.com

1516 MIDDLEBURY STREET
 ELKHART, IN 46516-4740
 USA

DOMESTIC CUSTOMER SERVICE
 PHONE: 800.234.0227
 FAX: 800.234.0557

TECHNICAL SERVICE
 PHONE: 888.446.4226
 FAX: 888.336.4226

INTERNATIONAL OFFICE
 PHONE: +1/574.295.3327
 FAX: +1/574.295.3455