

WATTS

TUBING PRICE LIST

NEW PRODUCTS /// ENHANCED SOLUTIONS

Effective Date June 1, 2016

Sioux Chief
tomahawk ///



www.gotomahawk.com



Table of Contents

1 Vinyl Tubing

Bulk Open Coil
PG 2

Coil in Cardboard Box
PG 3

EZ Dispenser Boxes
PG 5

Reels
PG 5

2 Braided Reinforced Vinyl Tubing

Bulk Open Coil
PG 6

Coil in Cardboard Box
PG 6

EZ Dispenser Boxes
PG 6

Reels
PG 6

3 Polyethylene Tubing — Low Density

Bulk Open Coil
PG 7

Coil in Cardboard Box
PG 7

EZ Dispenser Boxes
PG 7

Reels
PG 7

4 Water Hose

Bulk Open Coil
PG 8

5 Reel Tubing Program

Vinyl Tubing
PG 9

Braided Vinyl Tubing
PG 9

Tracer Hose
PG 10

Polyethylene Tubing - Low Density
PG 10

Latex Tubing
PG 10

Garden Hose
PG 10

Air Hose
PG 11

Spray Hose
PG 11

Washer Hose
PG 11

Heater Hose
PG 12

Utility Hose
PG 12

Polyurethane Micro Fuel Line
PG 12

Fuel Line
PG 12

Flexible PVC Spa Hose
PG 13

Pool & Spa Vacuum Hose
PG 13

Pump & Bilge Discharge Hose
PG 13

Flat Discharge Hose
PG 13

6 Tubing Rack

Tubing Rack
PG 14

7 Chemical Resistance Characteristics

Milky White Tubing
PG 15

Clear Tubing
PG 16

For product specs, more information can be found at www.gotomahawk.com/technical/technical-documents/spec-sheets.

Vinyl Tubing

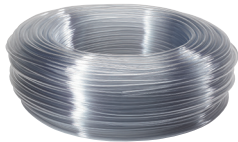
	WATTS MODEL NO.	TOMAHAWK ITEM NO.	DESCRIPTION	WORKING PRESSURE (psi @ 70°F)	MIN QTY.	TOMAHAWK LIST PRICE
/// BULK OPEN COIL						
	C1001	900-01001C05001	C003141 - VINYL TUBE 1/16 ID X 1/8 OD (1/32 WALL) CLEAR 500FT COIL	55	1	\$38.25
	C1003-500		OBSOLETE*			
	C1004-500	900-01053C05001	C000784 - VINYL TUBE 3/16 ID X 5/16 OD (1/16 WALL) CLEAR 500FT COIL	55	1	\$89.85
	C1004-1		OBSOLETE*			
	C1005	900-01056C05001	C003144 - VINYL TUBE 3/16 ID X 7/16 OD (1/8 WALL) CLEAR 500FT COIL	55	1	\$175.95
	C1006-500	900-01103C05001	C000790 - VINYL TUBE 1/4 ID X 3/8 OD (1/16 WALL) CLEAR 500FT COIL	55	1	\$104.23
	C1008	900-01106C05001	C003146 - VINYL TUBE 1/4 ID X 1/2 OD (1/8 WALL) CLEAR 500FT COIL	55	1	\$210.38
	C1010	900-01154C05001	C003147 - VINYL TUBE 5/16 ID X 1/2 OD (3/32 WALL) CLEAR 500FT	55	1	\$187.43
	C1010-1	900-01156C05001	C003148 - VINYL TUBE 5/16 ID X 9/16 OD (1/8 WALL) CLEAR 500FT COIL	55	1	\$192.78
	C1011-500	900-01163C05001	C001322 - VINYL TUBE 3/8 ID X 1/2 OD (1/16 WALL) CLEAR 500FT	45	1	\$139.61
	C1012-500		OBSOLETE*			
	C1013		OBSOLETE*			
	C1014		OBSOLETE*			
	C1015		OBSOLETE*			
	C1015-1		OBSOLETE*			
	C1016	900-01203C02501	C003153 - VINYL TUBE 1/2 ID X 5/8 OD (1/16 WALL) CLEAR 250FT COIL	45	1	\$81.47
	C1017-250	900-01206C02501	C001109 - VINYL TUBE 1/2 ID X 3/4 OD (1/8 WALL) CLEAR 250FT COIL	55	1	\$160.65
	C1018		OBSOLETE*			
	C1019		OBSOLETE*			
	C1019-1		OBSOLETE*			
	C1020	900-01253C02501	C003157 - VINYL TUBE 5/8 ID X 3/4 OD (1/16 WALL) CLEAR 250FT	30	1	\$104.71
	C1021		OBSOLETE*			
	C1022		OBSOLETE*			
	C1023		OBSOLETE*			
	C1024-100		OBSOLETE*			
	C1026-100	900-01406C01001	C001317 - VINYL TUBE 1 ID X 1 1/4 OD (1/8 WALL) CLEAR 100FT COIL	25	1	\$127.50
	C1026-1		OBSOLETE*			
	C1027		OBSOLETE*			
	C1027-1	900-01508C00501	C000876 - VINYL TUBE 1 1/4 ID X 1 5/8 OD (3/16 WALL) CLEAR 50 FT COIL	25	1	\$126.23
C1028	900-01609C00501	C001245 - VINYL TUBE 1 1/2 ID X 2 OD (1/4 WALL) CLEAR 50 FT COIL	25	1	\$172.04	
C1029	900-01608C00501	C000881 - VINYL TUBE 1 1/2 ID X 1 7/8 OD (3/16 WALL) CLEAR 50 FT COIL	25	1	\$143.63	

*Item discontinued prior to acquisition by Sioux Chief.

For product specs, more information can be found at www.gotomahawk.com/technical/technical-documents/spec-sheets.

Vinyl Tubing

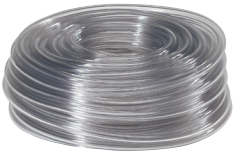
	WATTS MODEL NO.	TOMAHAWK ITEM NO.	DESCRIPTION	WORKING PRESSURE (psi @ 70°F)	MIN QTY.	TOMAHAWK LIST PRICE
/// COIL PACKAGED IN A CARDBOARD BOX						
	C1001A		OBSOLETE*			
	C1002A	900-01021C05002	C000771 - VINYL TUBE 1/8 ID X 3/16 OD (1/32 WALL) CLEAR 500FT COIL	55	1	\$47.77
	C1003A	900-01023C01002	C000775 - VINYL TUBE 1/8 ID X 1/4 OD (1/16 WALL) CLEAR 100FT	55	1	\$17.00
	C1004A	900-01053C01002	C000785 - VINYL TUBE 3/16 ID X 5/16 OD (1/16 WALL) CLEAR 100FT COIL	55	1	\$19.97
	C1004-1A	900-01051C01002	C000781 - VINYL TUBE 3/16 ID X 1/4 OD (1/32 WALL) CLEAR 100FT	55	1	\$19.97
	C1005A	900-01056C01002	C000789 - VINYL TUBE 3/16 ID X 7/16 OD (1/8 WALL) CLEAR 100FT COIL	55	1	\$39.10
	C1006A	900-01103C01002	C000791 - VINYL TUBE 1/4 ID X 3/8 OD (1/16 WALL) CLEAR 100FT COIL	55	1	\$23.16
	C1007A	900-01104C01002	C000800 - VINYL TUBE 1/4 ID X 7/16 OD (3/32 WALL) CLEAR 100FT	55	1	\$27.63
	C1008A		OBSOLETE*			
	C1009A	900-01153C01002	C000805 - VINYL TUBE 5/16 ID X 7/16 OD (1/16 WALL) CLEAR 100FT COIL	50	1	\$28.05
	C1010A	900-01154C01002	C000811 - VINYL TUBE 5/16 ID X 1/2 OD (3/32 WALL) CLEAR 100FT COIL	55	1	\$41.65
	C1010-1A		OBSOLETE*			
	C1011A	900-01163C01002	C000815 - VINYL TUBE 3/8 ID X 1/2 OD (1/16 WALL) CLEAR 100FT COIL	45	1	\$31.03
	C1012A	900-01164C01002	C000824 - VINYL TUBE 3/8 ID X 9/16 OD (3/32 WALL) CLEAR 100FT	55	1	\$46.75

**Item discontinued prior to acquisition by Sioux Chief.*

For product specs, more information can be found at www.gotomahawk.com/technical/technical-documents/spec-sheets.

Vinyl Tubing

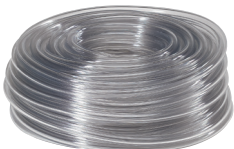
	WATTS MODEL NO.	TOMAHAWK ITEM NO.	DESCRIPTION	WORKING PRESSURE (psi @ 70°F)	MIN QTY.	TOMAHAWK LIST PRICE
/// COIL PACKAGED IN A CARDBOARD BOX (cont.)						
	C1013A	900-01166C01002	C000827 - VINYL TUBE 3/8 ID X 5/8 OD (1/8 WALL) CLEAR 100FT COIL	55	1	\$58.65
	C1014A		OBSOLETE*			
	C1015A		OBSOLETE*			
	C1015-1A		OBSOLETE*			
	C1016A	900-01203C01002	C000834 - VINYL TUBE 1/2 ID X 5/8 OD (1/16 WALL) CLEAR 100FT COIL	45	1	\$36.21
	C1016-1A	900-01204C01002	C000833 - VINYL TUBE 1/2 ID X 11/16 OD (3/32 WALL) CLEAR 100FT	50	1	\$55.25
	C1017A	900-01206C01002	C000841 - VINYL TUBE 1/2 ID X 3/4 OD (1/8 WALL) CLEAR 100FT COIL	55	1	\$71.40
	C1018A		OBSOLETE*			
	C1019A		OBSOLETE*			
	C1019-1A		OBSOLETE*			
	C1020A	900-01253C01002	C000845 - VINYL TUBE 5/8 ID X 3/4 OD (1/16 WALL) CLEAR 100FT COIL	30	1	\$46.54
	C1021A	900-01254C01002	C000851 - VINYL TUBE 5/8 ID X 13/16 OD (3/32 WALL) CLEAR 100FT COIL	45	1	\$76.50
	C1022A	900-01256C01002	C000852 - VINYL TUBE 5/8 ID X 7/8 OD (1/8 WALL) CLEAR 100FT COIL	40	1	\$86.70
	C1023A	900-01303C01002	C000858 - VINYL TUBE 3/4 ID X 7/8 OD (1/16) WALL CLEAR 100FT COIL	30	1	\$63.75
	C1023-1A		OBSOLETE*			
	C1024A	900-01306C01002	C000861 - VINYL TUBE 3/4 ID X 1 OD (1/8 WALL) CLEAR 100FT COIL	35	1	\$99.88
C1025A	900-01336C01003	C001116 - VINYL TUBE 7/8 ID X 1- 1/8 OD (1/8 WALL) CLEAR 100FT COIL	30	1	\$129.20	
C1026A	900-01406C01002	C000869 - VINYL TUBE 1 ID X 1 1/4 OD (1/8 WALL) CLEAR 100FT COIL	25	1	\$127.50	
C1026-1A	900-01404C01002	C000868 - VINYL TUBE 1 ID X 1 3/16 OD (3/32 WALL) CLEAR 100FT COIL	25	1	\$130.90	

**Item discontinued prior to acquisition by Sioux Chief.*

For product specs, more information can be found at www.gotomahawk.com/technical/technical-documents/spec-sheets.

Vinyl Tubing

	WATTS MODEL NO.	TOMAHAWK ITEM NO.	DESCRIPTION	WORKING PRESSURE (psi @ 70°F)	MIN QTY.	TOMAHAWK LIST PRICE
/// EZ DISPENSER BOXES						
	XVDC	900-01021C01005	43132100 - VINYL TUBE 1/8 ID X 3/16 OD (1/32 WALL) CLEAR 100FT EZ	55	1	\$10.62
	XVEC	900-01023C01005	43132200 - VINYL TUBE 1/8 ID X 1/4 OD (1/16 WALL) CLEAR 100FT EZ	55	1	\$17.00
	XVFD	900-01053C01005	43132300 - VINYL TUBE 3/16 ID X 5/16 OD (1/16 WALL) CLEAR 100FT EZ	55	1	\$19.97
	XVGE	900-01103C01005	43132400 - VINYL TUBE 1/4 ID X 3/8 OD (1/16 WALL) CLEAR 100FT EZ	55	1	\$23.16
	XVHF	900-01153C01005	43132500 - VINYL TUBE 5/16 ID X 7/16 OD (1/16 WALL) CLEAR 100FT EZ	50	1	\$28.05
	XVIF	900-01154C01005	43132600 - VINYL TUBE 5/16 ID X 1/2 OD (3/32 WALL) CLEAR 100FT EZ	55	1	\$41.65
	XVIG	900-01163C01003	43132640 - VINYL TUBE 3/8 ID X 1/2 OD (1/16 WALL) CLEAR 100FT	45	1	\$31.03
	XVJG	900-01164C01003	43132641 - VINYL TUBE 3/8 ID X 9/16 OD (3/32 WALL) CLEAR 100FT EZ	55	1	\$46.75
	XVKI	900-01203C01003	43132700 - VINYL TUBE 1/2 ID X 5/8 OD (1/16 WALL) CLEAR 100FT EZ	45	1	\$36.21
	XVLI	900-01206C01005	43132800 - VINYL TUBE 1/2 ID X 3/4 OD (1/8 WALL) CLEAR 100FT EZ	55	1	\$71.40
	XVMK	900-01256C01005	43132900 - VINYL TUBE 5/8 ID X 7/8 OD (1/8 WALL) CLEAR 100FT EZ	40	1	\$86.70
	XVNL	900-01306C00505	43132950 - VINYL TUBE 3/4 ID X 1 OD (1/8 WALL) CLEAR 50FT EZ	35	1	\$54.93
	XVPN	900-01406C00505	43132951 - VINYL TUBE 1 ID X 1 1/4 OD (1/8 WALL) CLEAR 50FT EZ	25	1	\$70.13
	/// REELS					
	C1002SC-300		OBSOLETE*			
	C1003SC-500		OBSOLETE*			
	C1004SC-300		OBSOLETE*			
	C1006SC-250		OBSOLETE*			
	C1009SC-275	900-01153C02754	C000809 - VINYL TUBE 5/16 ID X 7/16 OD (1/16 WALL) CLEAR 275FT REEL	50	1	\$69.42
	C1011SC-230	900-01163C02304	C000821 - VINYL TUBE 3/8 ID X 1/2 OD (1/16 WALL) CLEAR 230FT REEL	45	1	\$71.36
	C1016SC-100	900-01203C01004	C001463 - VINYL TUBE 1/2 ID X 5/8 OD (1/16 WALL) CLEAR 100FT REEL	45	1	\$36.21
	C1020SC-100	900-01253C01004	C000850 - VINYL TUBE 5/8 ID X 3/4 OD (1/16 WALL) CLEAR 100FT REEL	30	1	\$46.54
	C1024SC-50	900-01306C00504	C001162 - VINYL TUBE 3/4 ID X 1 OD (1/8 WALL) CLEAR 50FT REEL	35	1	\$54.93
	C1026SC-40	900-01406C00404	C000874 - VINYL TUBE 1 ID X 1 1/4 OD (1/8 WALL) CLEAR 40FT	25	1	\$61.20

*Item discontinued prior to acquisition by Sioux Chief.

For product specs, more information can be found at www.gotomahawk.com/technical/technical-documents/spec-sheets.

Braided Reinforced Vinyl Tubing

	WATTS MODEL NO.	TOMAHAWK ITEM NO.	DESCRIPTION	WORKING PRESSURE (psi @ 70°F)	MIN QTY.	TOMAHAWK LIST PRICE
/// BULK OPEN COIL						
	B5000-300		OBSOLETE*			
	B5001-300	900-02106C03001	C000738-BRAIDED VINYL TUBE 1/4 ID X 1/2 OD (1/8 WALL) CLEAR 300FT COIL	250	1	\$142.29
	B5011-300		OBSOLETE*			
	B5002	900-02166C01001	C000742 - BRAIDED VINYL TUBE 3/8 ID X 5/8 OD(1/8 WALL)CLEAR 100FT COIL	225	1	\$62.74
	B5003	900-02206C01001	C000746 - BRAIDED VINYL TUBE 1/2 ID X 3/4 OD(1/8 WALL)CLEAR 100FT COIL	200	1	\$78.65
	B5004	900-02256C01001	C000750 -BRAIDED VINYL TUBE 5/8 ID X 7/8 OD (1/8 WALL)CLEAR 100FT COIL	175	1	\$87.76
	B5005	900-02306C01001	C000753 - BRAIDED VINYL TUBE 3/4 ID X 1 OD (1/8 WALL) CLEAR 100FT COIL	150	1	\$104.58
	B5006	900-02408C01001	C000759-BRAIDED VINYL TUBE 1 ID X 1 3/8 OD (3/16 WALL)CLEAR 100FT COIL	125	1	\$198.00
	B5007		OBSOLETE*			
	B5008	900-02609C00501	C000762 -BRAIDED VINYL TUBE 1 1/2 ID X 2 OD (1/4 WALL) CLEAR 50FT COIL	75	1	\$229.10
	B5009	900-02709C00501	C000764-BRAIDED VINYL TUBE 2 ID X 2 1/2 OD (1/4 WALL CLEAR) 50FT COIL	70	1	\$280.50
/// COIL IN CARDBOARD BOX						
	B5000A		OBSOLETE*			
	B5001A	900-02106C01002	C000739-BRAIDED VINYL TUBE 1/4 ID X 1/2 OD (1/8 WALL) CLEAR 100FT COIL	250	1	\$52.70
	B5011A		OBSOLETE*			
	B5003A		OBSOLETE*			
	B5004A		OBSOLETE*			
	B5005A		OBSOLETE*			
	B5006A		OBSOLETE*			
/// EZ DISPENSER BOXES						
	XBVIE	900-02106C01005	43133200-BRAIDED VINYL TUBE 1/4 ID X 1/2 OD (1/8 WALL) CLEAR 100 FT EZ	250	1	\$52.70
	XBVKG	900-02166C01005	43133400-BRAIDED VINYL TUBE 3/8 ID X 5/8 OD(1/8 WALL) CLEAR 100FT EZ	225	1	\$62.74
	XBVLI	900-02206C01003	43133600-BRAIDED VINYL TUBE 1/2 ID X 3/4 OD(1/8) WALL CLEAR 100FT EZ	200	1	\$78.65
	XBVMK	900-02256C01005	43133700 -BRAIDED VINYL TUBE 5/8 ID X 7/8 OD(1/8 WALL) CLEAR 100FT EZ	175	1	\$87.76
	XBVNL	900-02306C00505	43133850 -BRAIDED VINYL TUBE 3/4 ID X 1 OD (1/8 WALL) CLEAR 50FT EZ	150	1	\$57.52
	XBVQN	900-02408C00503	43133950-BRAIDED VINYL TUBE 1 ID X 1 3/8 OD(3/16 WALL) CLEAR 50 FT EZ	125	1	\$108.90
/// REELS						
	B5001SC-200		OBSOLETE*			
	B5002SC-150	900-02166C01504	C001136 - BRAIDED VINYL TUBE 3/8 ID X 5/8 OD (1/8 WALL) CLEAR 150' CL	225	1	\$94.11
	B5003SC-75	900-02206C00753	C001138 - BRAIDED VINYL TUBE 1/2 ID X 3/4 OD (1/8 WALL) CLEAR 75' CL	200	1	\$64.89
	B5004SC-75		OBSOLETE*			

*Item discontinued prior to acquisition by Sioux Chief.

For product specs, more information can be found at www.gotomahawk.com/technical/technical-documents/spec-sheets.

Polyethylene Tubing - Low Density

	WATTS MODEL NO.	TOMAHAWK ITEM NO.	DESCRIPTION	WORKING PRESSURE (psi @ 70°F)	MIN QTY.	TOMAHAWK LIST PRICE
/// BULK OPEN COILS						
	P2001-500	901-03001W05001	C001527 - PE TUBE 1/8 OD X 1/16 ID (1/32 WALL) WHITE 500 FT COIL	140	1	\$41.00
	P2003-500	901-03020W05001	C000954 - PE TUBE 1/4 OD X 17/100 ID (1/25 WALL) WHITE 500 FT COIL	140	1	\$47.24
	P2004	901-03023W05001	C003176 - PE TUBE 1/4 OD X 1/8 ID (1/16 WALL) WHITE 500FT COIL	130	1	\$68.85
	P2005		OBSOLETE*			
	P2006-500	901-03103W05001	C000980 - PE TUBE 3/8 OD X 1/4 ID (1/16 WALL) WHITE 500 FT COIL	120	1	\$95.36
	P2007-500	901-03163W05001	C000992 - PE TUBE 1/2 OD X 3/8 ID (1/16 WALL) WHITE 500 FT COIL	100	1	\$119.68
	P2008	901-03163W02501	C003178 - PE TUBE 1/2 OD X 3/8 ID (1/16 WALL) WHITE 250FT COIL	85	1	\$59.84
	P2009-250	901-03206W02501	C001009 - PE TUBE 5/8 OD X3/8 ID (1/16 WALL) WHITE 250 FT COIL	100	1	\$107.10
	P2010-250	901-03253W02501	C001346 - PE TUBE 3/4 OD X 5/8 ID (1/16 WALL) WHITE 250 FT	60	1	\$114.75
	P2011-250		OBSOLETE*			
	P2012		OBSOLETE*			
	P2013-100		OBSOLETE*			
/// CARDBOARD BOXES						
	P2006A-100	901-03106W01002	C001290 - PE TUBE 3/8 OD X 1/4 ID (1/16 WALL) WHITE 100 FT COIL	120	1	\$21.52
	P2007A	901-03163W01002	C000994 - PE TUBE 1/2 OD X 3/8 ID (1/16 WALL) WHITE 100 FT COIL	100	1	\$26.60
/// EZ DISPENSER BOXES						
	XPEB	901-03020W01005	43131200 - PE TUBE 1/4 OD X 17/100 ID (1/25 WALL) WHITE 100FT EZ	140	1	\$12.35
	XPFD	901-03053W01005	43131300 - PE TUBE 5/16 OD X 3/16 ID (1/16 WALL) WHITE 100FT EZ	130	1	\$19.13
	XPGE	901-03103W01005	43131400 - PE TUBE 3/8 OD X 1/4 ID (1/16 WALL) WHITE 100FT EZ	120	1	\$21.52
	XPIG	901-03163W01005	43131600 - PE TUBE 1/2 OD X 3/8 ID (1/16 WALL) WHITE 100FT EZ	100	1	\$26.60
	XPKI	901-03203W010099	43131800 - PE TUBE 5/8 OD X 1/2 ID (1/16 WALL) WHITE 100FT EZ	85	1	\$35.70
/// REELS						
	P2003SC-500	901-03020W05004	C000965 - PE TUBE 1/4 OD X 17/100 ID (1/25 WALL) WHITE 500 FT REEL	140	1	\$47.24
	P2004SC-500	901-03023W05004	C000972 - PE TUBE 1/4 OD X 1/8 ID (1/16 WALL) WHITE 500 FT	130	1	\$68.85
	P2005SC-500	901-03053W05004	C000978 - PE TUBE 5/16 OD X 3/16 ID (1/16 WALL) WHITE 500 FT REEL	130	1	\$88.36
	P2006SC-500	901-03103W05004	C000988 - PE TUBE 3/8 OD X 1/4 ID (1/16 WALL) WHITE 500 FT REEL	120	1	\$95.36
	P2007SC-500		OBSOLETE*			

*Item discontinued prior to acquisition by Sioux Chief.

For product specs, more information can be found at www.gotomahawk.com/technical/documents/spec-sheets.

Water Hose

	WATTS MODEL NO.	TOMAHAWK ITEM NO.	DESCRIPTION	WORKING PRESSURE (psi @ 70°F)	MIN QTY.	TOMAHAWK LIST PRICE
/// BULK OPEN COIL						
	W5003-50-BLU		OBSOLETE*			
	W5003-50-RED		OBSOLETE*			
	W5004-50-BLU		OBSOLETE*			
	W5004		OBSOLETE*			
	W5004R		OBSOLETE*			
	W5005-50		OBSOLETE*			
	W5005	900-11300B01001	C001070 - WATER HOSE 3/4 ID BLUE 100FT COIL	200	1	\$127.50
	W5005-50-RED	900-11300R00501	C003195 - WATER HOSE 3/4 ID RED 50FT COIL	200	1	\$47.75

**Item discontinued prior to acquisition by Sioux Chief.*

For product specs, more information can be found at www.gotomahawk.com/technical/technical-documents/spec-sheets.

Reel Tubing Program

Reel Tubing is marked every foot





	WATTS MODEL NO.	TOMAHAWK ITEM NO.	DESCRIPTION	WORKING PRESSURE (psi @ 70°F)	MIN QTY.	TOMAHAWK LIST PRICE
/// VINYL TUBING						
	RVDC	900-01021C04005	42160041 - VINYL TUBE 1/8 ID X 3/16 OD (1/32 WALL) CLEAR 400 FT EZ	55	1	\$38.22
	RVEC	900-01023C04005	42161140 - VINYL TUBE 1/8 ID X 1/4 OD (1/16 WALL) CLEAR 400 FT EZ	55	1	\$61.20
	RVEB	900-01030C04005	42160401 - VINYL TUBE 17/100 ID X 1/4 OD (1/25 WALL) CLEAR 400 FT EZ	55	1	\$52.02
	RVFD	900-01053C03005	42161300 - VINYL TUBE 3/16 ID X 1/16 WALL CLEAR 300 FT	55	1	\$53.91
	RVGE	900-01103C02505	42162250 - VINYL TUBE 1/4 ID X 3/8 OD (1/16 WALL) CLEAR 250 FT EZ	55	1	\$52.12
	RVHF	900-01153C02005	42163200 - VINYL TUBE 5/16 ID X 7/16 OD (1/16 WALL) CLEAR 200 FT EZ	50	1	\$56.10
	RVIF	900-01154C01505	42165200 - VINYL TUBE 5/16 ID X 1/2 OD (3/32 WALL) CLEAR 150 FT EZ	50	1	\$62.48
	RVIG	900-01163C01005	42164100 - VINYL TUBE 3/8 ID X 1/2 OD (1/16 WALL) CLEAR 100 FT EZ	45	1	\$31.03
	RVJG	900-01164C01005	42164210 - VINYL TUBE 3/8 ID X 9/16 OD (3/32 WALL) CLEAR 100 FT EZ	45	1	\$46.75
	RVKI	900-01203C01005	42166100 - VINYL TUBE 1/2 ID X 5/8 OD (1/16 WALL) CLEAR 100 FT EZ	45	1	\$36.21
	RVLI	900-01206C00755	42167210 - VINYL TUBE 1/2 ID X 3/4 OD (1/8 WALL) CLEAR 75 FT EZ	55	1	\$58.91
	RVLK	900-01253C01005	42167100 - VINYL TUBE 5/8 ID X 3/4 OD (1/16 WALL) CLEAR 100 FT EZ	30	1	\$46.54
	RVMK	900-01256C01004	42167310 - VINYL TUBE 5/8 ID X 7/8 OD (1/8 WALL) CLEAR 100 FT REEL	40	1	\$86.70
	RVNL	900-01306C00755	42168075 - VINYL TUBE 3/4 ID X 1 OD (1/8 WALL) CLEAR 75 FT REEL	35	1	\$82.40
	RVPN	900-01406C01005	42169150 - VINYL TUBE 1 ID X 1 1/4 OD (1/8 WALL) CLEAR 100 FT REEL	25	1	\$127.50
	RVSP	900-01508C00504	42169160 - VINYL TUBE 1-1/4 ID X 1 5/8 OD (3/16 WALL) CLEAR 50 FT REEL	25	1	\$126.23
	RVUR	900-01608C00505	42169170 - VINYL TUBE 1-1/2 ID X 1 7/8 OD (3/16 WALL) CLEAR 50 FT REEL	25	1	\$143.63
	RVXV	900-01708C00255	42169190 - VINYL TUBE 2 ID X 2 3/8 OD (3/16 WALL) CLEAR 25 FT REEL	20	1	\$116.28
	RVDEB	900-01030N05005	42160400 - VINYL TUBE 17/100 ID X _ OD (1/25 WALL) BLACK 500 FT EZ	55	1	\$65.03
	RVBIG	900-01163N01005	42169210 - VINYL TUBE 3/8 ID X 1/2 OD (1/16 WALL) BLACK 100 FT EZ	45	1	\$31.03
RVBKI	900-01203N01005	42169310 - VINYL TUBE 1/2 ID X 5/8 OD (1/16 WALL) BLACK 100 FT EZ	45	1	\$36.21	
RVBLK	900-01253N01005	42169410 - VINYL TUBE 5/8 ID X 3/4 OD (1/16 WALL) BLACK 100 FT EZ	30	1	\$46.54	
/// BRAIDED VINYL TUBING						
	RBVIE	900-02106C02505	42172250 - BRAIDED VINYL TUBE 1/4 ID X 1/2 OD (1/8 WALL) CLEAR 250 FT REEL	250	1	\$118.58
	RBVKG	900-02166C01505	42174150 - BRAIDED VINYL TUBE 3/8 ID X 5/8 OD (1/8 WALL) CLEAR 150 FT REEL	225	1	\$94.11
	RVBLI	900-02206C01005	42176100 - BRAIDED VINYL TUBE 1/2 ID X 1/8 WALL CLEAR 100 FT COIL	200	1	\$78.65
	RBVMK	900-02256C00755	42177075 - BRAIDED VINYL TUBE 5/8 ID X 7/8 OD (1/8 WALL) CLEAR 75 FT REEL	175	1	\$72.40
	RVBNL	900-02306C00755	42178075 - BRAIDED VINYL TUBE 3/4 ID X 1 OD (1/8 WALL) CLEAR 75 FT REEL	150	1	\$86.28
	RBVQN	900-02408C00505	42178150 - BRAIDED VINYL TUBE 1 ID X 1 3/8 OD (3/16 WALL) CLEAR 50 FT REEL	125	1	\$108.90
	RBVTP	900-02509C00505	42178250 - BRAIDED VINYL TUBE 1-1/4 ID X 1 3/4 OD (1/4 WALL) CLEAR 50 FT REEL	100	1	\$190.83
	RBVVR	900-02609C00505	42178350 - BRAIDED VINYL TUBE 1 1/2 ID X 2 OD (1/4 WALL) CLEAR 50 FT REEL	75	1	\$229.10

*Item discontinued prior to acquisition by Sioux Chief.

For product specs, more information can be found at www.gotomahawk.com/technical/technical-documents/spec-sheets.

Reel Tubing is marked every foot

Reel Tubing Program



	WATTS MODEL NO.	TOMAHAWK ITEM NO.	DESCRIPTION	WORKING PRESSURE (psi @ 70°F)	MIN QTY.	TOMAHAWK LIST PRICE
/// TRACER HOSE						
	RBVRL	900-05306R00755	42178085 - TRACER BRAIDED VINYL 3/4 ID X 1 OD(1/8 WALL) RED 75FT REEL	150	1	\$91.80
	RBVBL	900-05306B00755	42178095 - TRACER BRAIDED VINYL 3/4 ID X 1 OD(1/8 WALL)BLUE 75FT REEL	150	1	\$91.80
/// POLYETHYLENE TUBING - LOW DENSITY						
	RPEB	901-03020W04005	42152400 - PE TUBE 1/4 OD X 8/100 WALL WHITE 400FT COIL	140	1	\$37.79
	RPFD	901-03053W03005	42153300 - PE TUBE 5/16 OD X 3/16 ID (1/16 WALL) WHITE 300FT EZ	130	1	\$53.01
	RPGE	901-03103W03005	42154300 - PE TUBE 3/8 OD X 1/4 ID (1/16 WALL) WHITE 300FT EZ	120	1	\$57.21
	RPIG	901-03163W02005	42156200 - PE TUBE 1/2 OD X 3/8 ID (1/16 WALL) WHITE 200FT REEL	100	1	\$53.19
	RPKI	901-03203W01005	42157100 - PE TUBE 5/8 OD X 1/2 ID (1/16 WALL) WHITE 100FT REEL	85	1	\$35.70
/// LATEX TUBING						
	RLGE	900-06103Y00505	42241050 - LATEX HOSE 1/4 ID X 3/8 OD (1/16 WALL) YELLOW 50FT REEL	N/A	1	\$71.00
/// GARDEN HOSE						
	RGMK	900-07256G01505	42217150 - GARDEN HOSE 5/8 ID X 7/8 OD (1/8 WALL) GREEN 150FT REEL	125	1	\$148.70

**Item discontinued prior to acquisition by Sioux Chief.*

For product specs, more information can be found at www.gotomahawk.com/technical/technical-documents/spec-sheets.

Reel Tubing Program

Reel Tubing is marked every foot





	WATTS MODEL NO.	TOMAHAWK ITEM NO.	DESCRIPTION	WORKING PRESSURE (psi @ 70°F)	MIN QTY.	TOMAHAWK LIST PRICE
/// AIR HOSE						
	RALI	900-08206001005	42185100 - AIR HOSE 1/2 ID X 3/4 OD (1/8 WALL) ORANGE 100 FT REEL	150	1	\$81.05
/// SPRAY HOSE						
	RSPKG	900-09166Y01004	42220100 - SPRAY HOSE 3/8 ID X 5/8 OD (1/8 WALL) YELLOW 100FT REEL	300	1	\$80.00
/// WASHER HOSE						
	RWNK	900-04258N00505	42197050 - WASHER HOSE 5/8 ID X 3/16 WALL BLACK 50FT COIL	200	1	\$77.78
	RWPM	900-04338N00255	42198025 - WASHER HOSE 7/8 ID X 1 1/4 OD (3/16 WALL) BLK X 25FT REEL	125	1	\$57.04

**Item discontinued prior to acquisition by Sioux Chief.*

For product specs, more information can be found at www.gotomahawk.com/technical/technical-documents/spec-sheets.

Reel Tubing is marked every foot

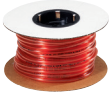
Reel Tubing Program

	WATTS MODEL NO.	TOMAHAWK ITEM NO.	DESCRIPTION	WORKING PRESSURE (psi @ 70°F)	MIN QTY.	TOMAHAWK LIST PRICE
/// HEATER HOSE						
	RHLK	900-12256N01005	42327100 - HEATER HOSE 5/8 ID X 7/8 OD (1/8 WALL) BLACK 100FT REEL	80	1	\$147.67
	RHNL	900-12306N00755	42328100 - HEATER HOSE 3/4 ID X 1 OD (1/8 WALL) BLACK 75FT REEL	80	1	\$166.32
/// UTILITY HOSE						
	RUTLI	900-13206R01005	42291100 - UTILITY HOSE 1/2 ID X 3/4 OD (1/8 WALL) RED 100FT REEL	200	1	\$168.30
	RUTOL	900-13308R00755	42293075 - UTILITY HOSE 3/4 ID 1 1/8 OD (3/16 WALL) RED 75FT REEL	200	1	\$199.54
/// POLYURETHANE MICRO FUEL LINE						
	RUFE	900-14010R01005	42206150 - MICRO FUEL LINE 7/64 ID X 1/4 OD ORANGE 100FT REEL	133	1	\$79.74
/// FUEL LINE						
	RFKF	900-15157N01005	42203100 - FUEL LINE 5/16 ID X 5/8 (5/32 WALL) BLACK 100FT REEL	175	1	\$97.05

**Item discontinued prior to acquisition by Sioux Chief.*

For product specs, more information can be found at www.gotomahawk.com/technical/technical-documents/spec-sheets.

Reel Tubing Program

Reel Tubing is marked every foot

	WATTS MODEL NO.	TOMAHAWK ITEM NO.	DESCRIPTION	WORKING PRESSURE (psi @ 70°F)	MIN QTY.	TOMAHAWK LIST PRICE
/// FLEXIBLE PVC SPA HOSE						
	RSFI	900-16200W01004	42280100 - FLEXIBLE PVC SPA HOSE 1/2 ID WHITE 100FT REEL	100	1	\$146.25
	RSFL	900-16300W01004	42281100 - FLEXIBLE PVC SPA HOSE 3/4 ID WHITE 100FT	100	1	\$189.00
	RSFN	900-16400W00504	42282050 - FLEXIBLE PVC SPA HOSE 1 ID WHITE 50FT REEL	100	1	\$123.75
	RSFP	900-16500W00504	42284050 - FLEXIBLE PVC SPA HOSE 1-1/4 ID WHITE 50FT REEL	80	1	\$158.82
	RSFR	900-16600W00504	42283050 - FLEXIBLE PVC SPA HOSE 1-1/2 ID WHITE 50FT REEL	65	1	\$162.36
POOL & SPA VACUUM HOSE						
	RPSP	900-17500B00504	42260050 - POOL & SPA VAC HOSE 1-1/4 ID BLUE 50FT REEL	N/A	1	\$105.66
	RPSR	900-17600B00504	42261050 - POOL & SPA HOSE 1-1/2 ID BLUE 50FT EZ	N/A	1	\$121.60
PUMP & BILGE DISCHARGE HOSE						
	RBBO	900-18430W00505	42180785 - PUMP & BILGE HOSE 1-1/8 ID WHITE 50FT REEL	N/A	1	\$64.28
	RBBP	900-18500W00505	42180795 - PUMP & BILGE HOSE 1-1/4 ID WHITE 50FT REEL	N/A	1	\$83.38
	RBBR	900-18600W00505	42180765 - PUMP AND BILGE HOSE 1-1/2 ID WHITE 50FT REEL	N/A	1	\$81.51
FLAT DISCHARGE HOSE						
	RCDR	900-19600B01505	42252050 - FLAT DISCHARGE HOSE 1-1/2 ID BLUE 150FT COIL	70	1	\$79.79
	RCDV	900-19700B01505	42252150 - FLAT DISCHARGE HOSE ECONO 2 ID BLUE 150FT REEL	65	1	\$142.50

**Item discontinued prior to acquisition by Sioux Chief.*

For product specs, more information can be found at www.gotomahawk.com/technical/technical-documents/spec-sheets.

Tubeing Rack

TOMAHAWK ITEM NO.	DESCRIPTION
42143028	COMPLETE TUBING RACK KIT 4FT X 7FT WITHOUT SIGN

TOMAHAWK ITEM NO.	DESCRIPTION
42131025	COMPLETE TUBING RACK KIT 8FT X 7FT WITHOUT SIGN

TOMAHAWK ITEM NO.	DESCRIPTION	QUANTITY WITH 4' RACK
94630591	UPRIGHT - 7 HOOK	5
94630575	CROSS BRACE - 8 IN	6
94630574	CROSS BRACE - 13 IN	6
94630573	REEL HOLDER - 8 IN	14
94630572	REEL HOLDER - 13 IN	14
94630598	LARGE ARM	28
94630596	SIGN HANGER	-
94630584	1/4 - 20 X 2 BOLTS	20
94630585	1/4 - 20 HEX NUTS	20

TOMAHAWK ITEM NO.	DESCRIPTION	QUANTITY WITH 8' RACK
94630591	UPRIGHT - 7 HOOK	10
94630575	CROSS BRACE - 8 IN	18
94630574	CROSS BRACE - 13 IN	6
94630573	REEL HOLDER - 8 IN	29
94630572	REEL HOLDER - 13 IN	14
94630598	LARGE ARM	28
94630579	X- LARGE ARM	15
94630596	SIGN HANGER	-
94630584	1/4 - 20 X 2 BOLTS	30
94630585	1/4 - 20 HEX NUTS	30

Contact your local rep to confirm price and availability.

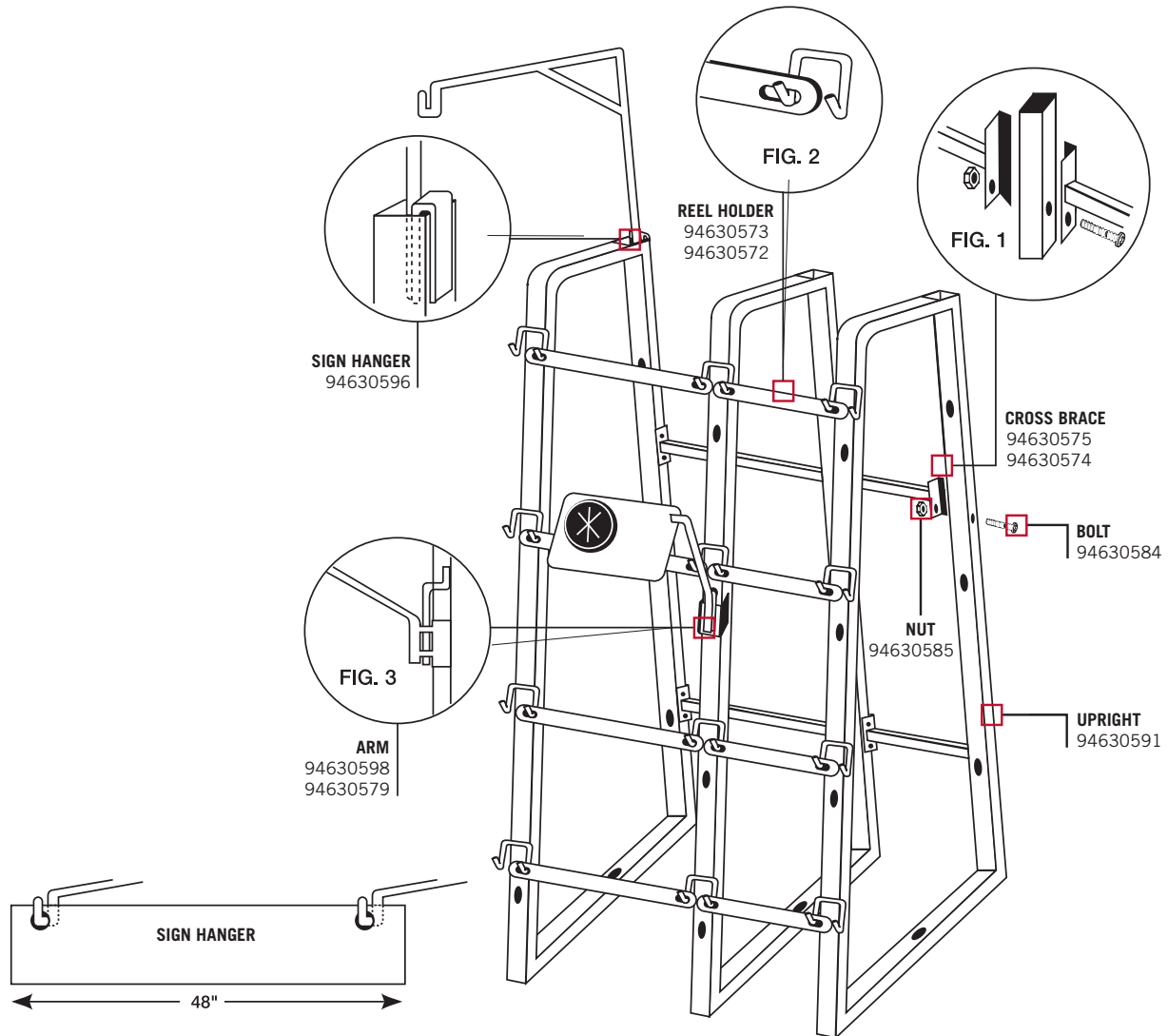

For product specs, more information can be found at www.gotomahawk.com/technical/technical-documents/spec-sheets.

Chemical Resistance Characteristics of Polyethylene

Milky White

Excellent Resistance

Acetamide	Calcium Hypochloride	Formaldehyde (40%)	Oxalic Acid (Sat.)	Sodium Benzoate (35%)
Acetic Acid (100%)	Calcium Nitrate (50%)	Formic Acid (100%)	Palmitic Acid	Sodium Bicarbonate (Sat.)
Acrylic Emulsions	Calcium Sulfate	Fructose (Sat.)	Perchloric Acid (10%)	Sodium Bisulfate (Sat.)
Adipic Acid	Carbozole	Fruit Pulp	Phenol (50%)	Sodium Bisulfite (Sat.)
Alanine	Carbon Dioxide Wet/Dry (100%)	Gallic Acid (Sat.)	Phosphorous Pentoxide (100%)	Sodium Bromide (Conc.)
Allyl Alcohol	Carbone Monoxide	Gin	Phosphorous Trichloride (100%)	Sodium Carbonate
Aluminum Chloride (Cons.)	Carbonic Acid	Glucose	Photographic Solutions	Sodium Chlorate (Sat.)
Aluminum Fluoride (Conc.)	Castor Oil	Glycerine	Pickling Baths:	Sodium Chloride (Sat.)
Aluminum Hydroxide	Cellosolve Acetate	Glycols	Sulfuric Acid, Hydrochloric Acid	Sodium Cyanide
Aluminum Sulfate (Conc.)	Cesium Salts	Glycolic Acid (30%)	Sulfuric-Nitric	Sodium Dichromate (Sat.)
Alums (All Types Conc.)	Chloride Water (Sat.)	Grape Sugar (Sat.)	Picric Acid (1%)	Sodium Ferricyanide (Sat.)
Amino Acids	Chromic Acid (50%)	Hydrobromic Acid (50%)	Plating Solutions:	Sodium Ferrocyanide (Sat.)
Ammonia Dry Gas (100%)	Chrome Alum (Sat.)	Hydrochloric Acid (40%)	Brass, Cadmium, Chromium, Copper	Sodium Fluoride (Sat.)
Ammonium Acetate (Sat.)	Cider	Hydrocyanic Acid (Sat.)	Gold, Indium, Lead, Nickel, Rhodium	Sodium Hexametaphosphate
Ammonium Carbonate	Citric Acid	Hydrofluoric Acid (60%)	Silver, Tin, Zinc	Sodium Hydroxide
Ammonium Chloride (Sat.)	Coconut Oil	Hydrogen (100%)	Potassium Bicarbonate (Sat.)	Sodium Hypochlorite
Ammonium Fluoride (Sat.)	Cottonseed Oil	Hydrogen Chloride Gas (Dry)	Potassium Borate (1%)	Sodium Nitrate
Ammonium Hydroxide (Conc.)	Cupric Chloride (Sat.)	Hydrogen Peroxide (30%)	Potassium Bromate (10%)	Sodium Sulfate
Ammonium Metaphosphate (Sat.)	Cupric Cyanide (Sat.)	Hydrogen Phosphide (100%)	Potassium Bromide (Sat.)	Sodium Sulfide (Sat.)
Ammonium Nitrate (Sat.)	Cupric Fluoride (Sat.)	Hydroquinone	Potassium Carbonate	Sodium Sulfite
Ammonium Oxalate	Cupric Nitrate (Sat.)	Hydrogen Sulfide	Potassium Chlorate (Sat.)	Sour Crude
Ammonium Sulfate (Sat.)	Cupric Sulfate	Hypochlorous Acid (Conc.)	Potassium Chloride (Sat.)	Stannous Chloride (Sat.)
Ammonium Sulfide (Sat.)	Cuprous Chloride (Sat.)	Inks	Potassium Chromate (40%)	Stannic Chloride (Sat.)
Aniline	Cyclohexane	Isopropyl Acetate	Potassium Dichromate (Sat.)	Starch Solution (Sat.)
Antimony Salts	Detergents, Synthetic	Isopropyl Alcohol	Potassium Cyanide (Sat.)	Stearic Acid (100%)
Arsenic Acid (80%)	Developers, Photographic	Lactic Acid	Potassium Ferri/Ferro Cyanide (Sat.)	Sulfur
Arsenic Salts	Dextrin	Latex	Potassium Fluoride	Sulfuric Acid To 70%
Barium Carbonate (Sat.)	Dextrose	Lead Salts	Potassium Hydroxide	Sulfur Dioxide
Barium Chloride (Sat.)	Diethyl Ketone	Lithium Salts	Potassium Nitrate (Sat.)	Sulfur Salts
Barium Hydroxide	Dimethyl Formamide	Magnesium Carbonate (Sat.)	Potassium Perborate (Sat.)	Sulfurous Acid
Sulfate (Sat.)	Dimethyl Sulfoxide	Magnesium Chloride (Sat.)	Potassium Perchlorate (10%)	Tallow
Barium Sulfide (Sat.)	Dipropylene Glycol	Magnesium Hydroxide (Sat.)	Potassium Permanganate (20%)	Tannic Acid (Conc.)
Beer	Disodium Phosphate	Magnesium Nitrate (Sat.)	Potassium Sulfate (Conc.)	Tartaric Acid (Sat.)
Benzenesulfonic Acid (10%)	Diazo Salts	Malic Acid (10%)	Potassium Sulfide (Conc.)	Triethylene Glycol
Benzoic Acid (Sat.)	Emulsions, Photographic	Mercuric Chloride (Sat.)	Potassium Sulfite (Conc.)	Tripropylene Glycol
Benzyl Acetate	Ethyl Acetate (100%)	Mercuric Cyanide (Sat.)	Potassium Persulfate (Sat.)	Trisodium Phosphate
Bismuth Salts	Ethyl Alcohol (100%)	Mercurous Nitrate (Sat.)	Propargyl Alcohol	Turkey Red Oil
Bleach Lye (10%)	Ethyl Benzoate	Mercury	Propyl Alcohol	Undacyl Alcohol
Boric Acid	Ethyl Cyanoacetate	Methyl Alcohol (100%)	Propylene Glycol	Urea
Boron Salts	Ethyl Lactate	Methyl Isobutyl Ketone	Resorcinol	Urine
Brine	Ethylene Glycol	Methyl Propyl Ketone	Salicylaldehyde	Vinegar
N-Butyl Acetate (100%)	Fatty Acids	Methyl Sulfuric Acid	Salicylic Acid	Vanilla Extract
N-Butyl Alcohol (100%)	Ferric Chloride (Sat.)	Milk	Salt Solutions	Wetting Agents
Iso-Butyl Alcohol (100%)	Ferric Nitrate (Sat.)	Molasses	Sea Water	Whiskey
Butanediol	Ferrous Chloride (Sat.)	Nickel Chloride (Sat.)	Selinic Acid	Wines
Cadmium Salts	Ferrous Sulfate	Nickel Nitrate (Conc.)	Shortening	Yeast
Calcium Hydroxide	Fish Solubles	Nickel Sulfate (Sat.)	Silver Acetate	Zinc Chloride (Sat.)
Calcium Bisulfide	Fluoboric Acid	Nicotine (Dilute)	Silver Nitrate	Zinc Stearate
Calcium Carbonate (Sat.)	Fluosilicic Acid (Conc.)	Nicotinic Acid (55%)	Silver Salts	Zinc Sulfate (Sat.)
Calcium Chlorate (Sat.)	Fluorides	N-Octane	Soap Solution	
Calcium Chloride (Sat.)	Freon 12	Orange Extract	Sodium Acetate (Sat.)	

Fair to Good Resistance

Acetaldehyde	Chlorine Gas (100%)	Fluorine	Methyl Ethyl Ketone (100%)	Ozone
Acetone	Chloroform (100%)	Fuel Oil	Methylene Chloride (100%)	Petroleum Ether
Ammonia Liquid	Cyclohexanone	Furfural (100%)	Mineral Oils	Propylene Dichloride
Amyl Acetate (100%)	Decalin	Furfural Alcohol	Naphtha	Sulfuric Acid (80%)
Benzene	Diocyl Phthalate	Heptane	Naphthalene	Tetrahydrofuran
Bromine Water	Ethyl Bromide	Iodine	Nitric Acid (70%)	Transformer Oil
Camphor Oil	Ethyl Chloride	Linseed Oil	Oils And Fats	Trichloroethylene
Chloroacetic Acid (100%)	Ethylene Oxide	Methyl Bromide	Oleic Acid	

Poor Resistance

Amyl Chloride (100%)	Carbon Disulfide	O-Dichlorobenzene	Hexane	Thionyl Chloride
Aqua Regia	Carbon Tetrachloride	P-Dichlorobenzene	Nitrobenzene (100%)	Trichloroethane
Benzaldehyde	Cedarwood Oil	Diethyl Benzene	Lube Oil	Trichloroethylene
Benzyl Alcohol	Chlorine Liquid	Ether	Perchloric Acid	Vinylidene Chloride
Bromine Gas/Liquid	Chlorobenzene	Ethyl Benzene	Perchlorethylene	
Bromobenzene	Chlorosulfonic Acid	Ethyl Butyrate	Sulfur Dioxide (40 Psi)	
Butadiene	Cinnamon Oil	Ethyl Chloride	Sulfuric Acid (96%)	
Butyric Acid	Cresol	Ethylene Chloride	Sulfuric Acid, Fuming	

The above table and recommendations are accurate to the best of our knowledge. No guarantees are expressed or implied.

For product specs, more information can be found at www.gotomahawk.com/technical/technical-documents/spec-sheets.

Chemical Resistance Characteristics of Vinyl or PVC Clear Tubing

Excellent Resistance

Acetic Acid	Essential Oils	Oil
Air	Ethyl Alcohol	Oxalic Acid
Alcohols	Ethyl Chloride	Oxygen
Aluminum Chloride	Ethylene Glycol	Palmitic Acid
Aluminum Sulfate	Fatty Acid	Picric Acid
Alums	Ferric Chloride	Phosphoric Acid
Ammonia Gas	Ferric Sulfate	Potassium Chloride
Ammonium Chloride	Fluoboric Acid	Potassium Sulfate
Ammonium Nitrate	Fluosilicic Acid	Propane
Ammonium Phosphate	Formic Acid	Pyrethrum
Ammonium Sulfate	Formaldehyde	Sodium Bisulfite
Amyl Alcohol	Freon	Sodium Bicarbonate
Animal Oils	Gallic Acid	Sodium Borate
Antimony Salts	Gas (Natural)	Sodium Carbonate
Arsenic Salts	Gasoline (Non-Aromatic)	Sodium Chloride
Barium Salts	Gelatin	Sodium Cyanide
Basic Copper Arsenate	Glue (Depending On Type)	Sodium Hydroxide
Beer	Glucose	Sodium Hypochlorite
Benzoic Acid	Glycerine	Sodium Nitrate
Benzyl Alcohol	Hydrochloric Acid	Sodium Phosphate
Boric Acid	Hydrocyanic Acid	Sodium Silicate
Boric Copper Sulfate	Hydrofluoric Acid	Sodium Sulfide
Bordeaux Mixture	Hydraulic Oil	Sodium Sulfate
Butanol	Hydrogen Gas	Sodium Thiosulfate
Butter	Hydrogen Peroxide (Dil.)	Stearic Acid
Calcium Hydroxide	Hydrogen Sulfide	Stannous Chloride
Calcium Hypochlorite	Lactic Acid	Sulphur Dioxide
Calcium Salts	Lard	Sulfuric Acid (Dil.)
Carbolic Acid	Lead Arsenate	Sulfurous Acid
Carbon Monoxide	Lead Sulfate	Tannic Acid
Corn Oil	Lime	Tartaric Acid
Cottonseed Oil	Linseed Oil	Tar Oil
Caustic Potash (-20%)	Magnesium Chloride	Turpentine
Caustic Soda (-20%)	Magnesium Hydroxide	Urea
Chloroform	Magnesium Sulfate	Uric Acid
Chromic Acid	Makeic Acid	Vinegar
Chlorine (Dry)	Milk	Water
Chlorine (Water)	Mineral Oil	Whiskey
Chromium Salts	Molasses	Wine
Copper Chloride	Nickel Chloride	Wool Oil
Copper Sulfate	Nicotine	Zinc Chloride
Citric Acid	Nitric Acid 20%	Zinc Hydrate
Cresylic Acid	Nitrogen Oxide	Zinc Sulfate
Cupric Sulfate	Nitrous Acid	

Fair to Good Resistance

Aniline	Caustic Soda (+20%)	Pentane
Benzine	Chlordane	Perchloric Acid
Benzol	Creosote	Perchlorethylene
Borax	Ether	Phenolates
Butane	Gasoline (Aromatic)	Phenols
Bromine	Hydrogen Peroxide (Conc.)	Stoddard Solvent
Calcium Bisulfide	Kerosene	Sulfuric Acid (Conc.)
Calcium Chloride	Mercuric Chloride	Trichloroethylene
Carbon Tetrachloride	Oleic Acid	Trichloroacetic Acid
Caustic Potash (+20%)		

Poor Resistance

Acetic Anhydride	Chloroacetic Acid	Lacquer Solvents
Acetone	Cresols	Naphtha
Acetyl Bromide	Cyclohexanone	Nitrobenzene
Acetyl Chloride	Ethyl Acetate	Paint Solvents
Ammonium Hydroxide	Ethylene Dischloride	Pyridine
Amyl Acetate	Fuel Oil (Aromatic Gas)	Toluene
Aromatic Hydrocarbons	Fuel Oil (Aromatic Gas)	Toluol
Butyl Acetate	Isopropyl Acetate	Xylol
Carbon Bisulfide	Ketones	Xylene

The above table and recommendations are accurate to the best of our knowledge. No guarantees are expressed or implied.

For product specs, more information can be found at www.gotomahawk.com/technical/technical-documents/spec-sheets.

APPENDIX

NUMERICAL INDEX 18

Numerical Index

WATTS MODEL NO.	TOMAHAWK ITEM NO.	PAGE NO.	WATTS MODEL NO.	TOMAHAWK ITEM NO.	PAGE NO.	WATTS MODEL NO.	TOMAHAWK ITEM NO.	PAGE NO.
B5000-300	-	6	C1019-1	-	2	RPKI	901-03203W01005	10
B5000A	-	6	C1019-1A	-	4	RPSP	900-17500B00504	13
B5001-300	900-02106C03001	6	C1019A	-	4	RPSR	900-17600B00504	13
B5001A	900-02106C01002	6	C1020	900-01253C02501	2	RSFI	900-16200W01004	13
B5001SC-200	-	6	C1020A	900-01253C01002	4	RSFL	900-16300W01004	13
B5002	900-02166C01001	6	C1020SC-100	900-01253C01004	5	RSFN	900-16400W00504	13
B5002SC-150	900-02166C01504	6	C1021	-	2	RSFP	900-16500W00504	13
B5003	900-02206C01001	6	C1021A	900-01254C01002	4	RSFR	900-16600W00504	13
B5003A	-	6	C1022	-	2	RSPKG	900-09166Y01004	11
B5003SC-75	900-02206C00753	6	C1022A	900-01256C01002	4	RUFE	900-14010R01005	12
B5004	900-02256C01001	6	C1023	-	2	RUTLI	900-13206R01005	12
B5004A	-	6	C1023-1A	-	4	RUTOL	900-13308R00755	12
B5004SC-75	-	6	C1023A	900-01303C01002	4	RVBIG	900-01163N01005	9
B5005	900-02306C01001	6	C1024-100	-	2	RVBKI	900-01203N01005	9
B5005A	-	6	C1024A	900-01306C01002	4	RVBLK	900-01253N01005	9
B5006	900-02408C01001	6	C1024SC-50	900-01306C00504	5	RVDC	900-01021C04005	9
B5006A	-	6	C1025A	900-01336C01003	4	RVDEB	900-01030N05005	9
B5007	-	6	C1026-1	-	2	RVEB	900-01030C04005	9
B5008	900-02609C00501	6	C1026-100	900-01406C01001	2	RVEC	900-01023C04005	9
B5009	900-02709C00501	6	C1026-1A	900-01404C01002	4	RVFD	900-01053C03005	9
B5011-300	-	6	C1026A	900-01406C01002	4	RVGE	900-01103C02505	9
B5011A	-	6	C1026SC-40	900-01406C00404	5	RVHF	900-01153C02005	9
C1001	900-01001C05001	2	C1027	-	2	RVIF	900-01154C01505	9
C1001A	-	3	C1027-1	900-01508C00501	2	RVIG	900-01163C01005	9
C1002A	900-01021C05002	3	C1028	900-01609C00501	2	RVJG	900-01164C01005	9
C1002SC-300	-	5	C1029	900-01608C00501	2	RVKI	900-01203C01005	9
C1003-500	-	2	P2001-500	901-03001W05001	7	RVLI	900-01206C00755	9
C1003A	900-01023C01002	3	P2003-500	901-03020W05001	7	RVLK	900-01253C01005	9
C1003SC-500	-	5	P2003SC-500	901-03020W05004	7	RVMK	900-01256C01004	9
C1004-1	-	2	P2004	901-03023W05001	7	RVNL	900-01306C00755	9
C1004-1A	900-01051C01002	3	P2004SC-500	901-03023W05004	7	RVPN	900-01406C01005	9
C1004-500	900-01053C05001	2	P2005	-	7	RVSP	900-01508C00504	9
C1004A	900-01053C01002	3	P2005SC-500	901-03053W05004	7	RVUR	900-01608C00505	9
C1004SC-300	-	5	P2006-500	901-03103W05001	7	RVXV	900-01708C00255	9
C1005	900-01056C05001	2	P2006A-100	901-03106W01002	7	RWNK	900-04258N00505	11
C1005A	900-01056C01002	3	P2006SC-500	901-03103W05004	7	RWPM	900-04338N00255	11
C1006-500	900-01103C05001	2	P2007-500	901-03163W05001	7	W5003-50-BLU	-	8
C1006A	900-01103C01002	3	P2007A	901-03163W01002	7	W5003-50-RED	-	8
C1006SC-250	-	5	P2007SC-500	-	7	W5004	-	8
C1007A	900-01104C01002	3	P2008	901-03163W02501	7	W5004-50-BLU	-	8
C1008	900-01106C05001	2	P2009-250	901-03206W02501	7	W5004R	-	8
C1008A	-	3	P2010-250	901-03253W02501	7	W5005	900-11300B01001	8
C1009A	900-01153C01002	3	P2011-250	-	7	W5005 50-RED	900-11300R00501	8
C1009SC-275	900-01153C02754	5	P2012	-	7	W5005-50	-	8
C1010	900-01154C05001	2	P2013-100	-	7	XBVIE	900-02106C01005	6
C1010-1	900-01156C05001	2	RALI	900-08206001005	11	XBVKG	900-02166C01005	6
C1010-1A	-	3	RBBO	900-18430W00505	13	XBVLI	900-02206C01003	6
C1010A	900-01154C01002	3	RBBP	900-18500W00505	13	XBVMK	900-02256C01005	6
C1011-500	900-01163C05001	2	RBBR	900-18600W00505	13	XBVNL	900-02306C00505	6
C1011A	900-01163C01002	3	RBVBL	900-05306B00755	10	XBVQN	900-02408C00503	6
C1011SC-230	900-01163C02304	5	RBVIE	900-02106C02505	9	XPEB	901-03020W01005	7
C1012-500	-	2	RBVKG	900-02166C01505	9	XPDF	901-03053W01005	7
C1012A	900-01164C01002	3	RBVLI	900-02206C01005	9	XPGE	901-03103W01005	7
C1013	-	2	RBVMK	900-02256C00755	9	XPIG	901-03163W01005	7
C1013A	900-01166C01002	4	RVNLI	900-02306C00755	9	XPKI	901-03203W010099	7
C1014	-	2	RBVQN	900-02408C00505	9	XVDC	900-01021C01005	5
C1014A	-	4	RBVRL	900-05306R00755	10	XVEC	900-01023C01005	5
C1015	-	2	RBVTP	900-02509C00505	9	XVFD	900-01053C01005	5
C1015-1	-	2	RBVVR	900-02609C00505	9	XVGE	900-01103C01005	5
C1015-1A	-	4	RCDR	900-19600B01505	13	XVHF	900-01153C01005	5
C1015A	-	4	RCDV	900-19700B01505	13	XVIF	900-01154C01005	5
C1016	900-01203C02501	2	RFKF	900-15157N01005	12	XVIG	900-01163C01003	5
C1016-1A	900-01204C01002	4	RGMK	900-07256G01505	10	XVJG	900-01164C01003	5
C1016A	900-01203C01002	4	RHLK	900-12256N01005	12	XVKI	900-01203C01003	5
C1016SC-100	900-01203C01004	5	RHNL	900-12306N00755	12	XVLI	900-01206C01005	5
C1017-250	900-01206C02501	2	RLGE	900-06103Y00505	10	XVMK	900-01256C01005	5
C1017A	900-01206C01002	4	RPEB	901-03020W04005	10	XVNL	900-01306C00505	5
C1018	-	2	RPFD	901-03053W03005	10	XVPN	900-01406C00505	5
C1018A	-	4	RPGE	901-03103W03005	10			
C1019	-	2	RPIG	901-03163W02005	10			

For product specs, more information can be found at www.gotomahawk.com/technical/technical-documents/spec-sheets.



Tomahawk
24110 South Peculiar Drive
Peculiar, Missouri 64078

P 1.800.821.3944
F 1.800.758.5950
www.gotomahawk.com